

# Valves, Fittings & Tubing

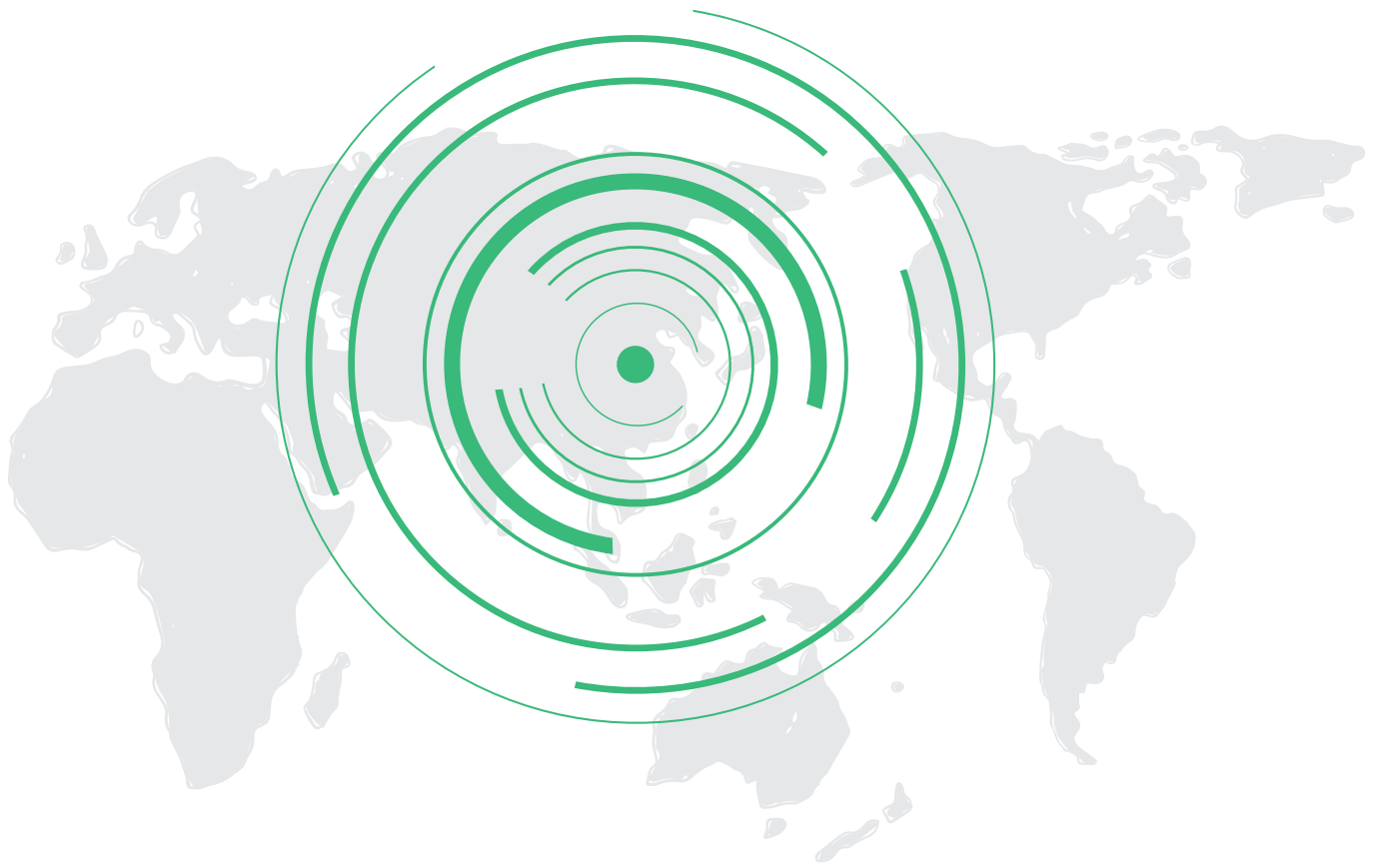



HiFluid, located in Ji'nan, China, national high-tech enterprise, science and technology-based SME, has been focusing on providing safe, stable, intelligent, and customized solutions for advanced ultra-high-pressure fluid applications such as hydrogen compression, high-pressure testing, high-pressure processing (HPP), solid-electrolyte battery production etc. as well as pressure generation unit and control & transfer unit for standard ultra-high-pressure fluid systems since its establishment in 2019. Leveraging its core competencies in design, equipment, and quality assurance, the company is committed to helping customers minimize lifecycle operational costs through energy-saving technologies and extended maintenance intervals.

The company has achieved certifications for ISO 9001 Quality Management System, ISO 14001 Environmental Management System, and ISO 45001 Occupational Health and Safety Management System. We strive to differentiate ourselves from traditional suppliers by embodying the role of consultants and solution providers with our expertise and craftsmanship.

*All greatness comes from a brave beginning.*



# Coding Rules

Pressure Rating		Component Type			Connection Type	Connection Size		Options		
15	15,000psi	V1	Valves	2-Way Straight	B	BSP Pipe	4	1/4"	AVA	Anti-Vibration Collet Gland Assemblies
20	20,000psi	V2	Valves	2-Way Angle	P	NPT Pipe	5	5/16"	B	Cryogenic Packing -73°C (-100°F)
30	30,000psi	V3	Valves	3-Way, 2 on Pressure	M	Medium Pressure	6	3/8"	GY	Graphite Braided Yarn Packing 426°C (799°F)
43	43,000psi	V4	Valves	3-Way, 1 on Pressure	H	High Pressure	8	1/2"	HT	High Temperature Option 649°C (1200°F)
60	60,000psi	V5	Valves	3-Way, 2-Stem Manifold	U	Utal-High Pressure	9	9/16"	LT	Low Temperature Option -253°C (-423°F)
100	100,000psi	V61	Valves	O-Ring Check Valves			12	3/4"	TG	Teflon Glass Packing 315°C (600°F)
150	150,000psi	V62	Valves	Ball Check Valves			16	1"	MNO	Light-Duty NO Actuator
		V7	Valves	Relief Valves			24	1-1/2"	HNO	Heavy-Duty NO Actuator
		F1	Fittings	Straight Coupling					MNC	Light-Duty NC Actuator
		F2	Fittings	Elbow					HNC	Heavy-Duty NC Actuator
		F3	Fittings	Tee					MDA	Light-Duty DA Actuator
		F4	Fittings	Cross					HDA	Heavy-Duty DA Actuator
		F51	Fittings	Adapters (Male to Female)					H2	Hydrogen Service
		F52	Fittings	Couplings (Female to Female)					O2	Oxygen Service
		F53	Fittings	Adapters (Male to Male)					R	Regulating Stem
		F61	Fittings	Dual-Disc Line Filters					RC	Regulating Stem with Replaceable Seat
		F62	Fittings	Cup-Type Line Filters					C	Vee Stem with Replaceable Seat
		F63	Fittings	Angel Filters					WO	Without Collar and Gland
		F71	Fittings	Gland						
		F72	Fittings	Collar						
		F73	Fittings	Plug						
		F74	Fittings	Tubing Cap						
		F75	Fittings	Ferrule						
		F8	Fittings	Anti-Vibration Collet Gland Assemblies						
		T4	Tubing	1/4"						
		T5	Tubing	5/16"						
		T6	Tubing	3/8"						
		T9	Tubing	9/16"						
		T12	Tubing	3/4"						
		T16	Tubing	1"						
		T24	Tubing	1-1/2"						

- Low Pressure
- Medium Pressure
- High Pressure
- Ultra-High Pressure
- Technical Information



# Low Pressure

to 15,000psi (1,034bar)

HiFluid's low-pressure product portfolio comprises needle valves (hand-operated), actuator needle valves, check valves, relief valves, filters, and fittings. All valves use the NPT and BSP connection, fittings use the NPT connection for reliable sealing and pressure stability.



### Needle Valves (Hand-Operated)

A needle valve controls gas or liquid flow by manually adjusting the stem travel. Precision flow-control models are available as required. Each valve body is laser-etched with model, serial number, maximum working pressure, and primary material to ensure full traceability and compliance with standardized quality control.

#### Features

- Non-rotating rising stem design minimizes wear between needle and seat, extending service life.
- 316L duplex wetted parts and 17-4PH stem for outstanding mechanical strength and excellent corrosion resistance.
- Metal-to-metal seating provides long-term stability under high pressure and frequent cycling.

### Actuator Needle Valves

An actuator needle valve uses an air actuator to open/close the needle for remote automation. The piston-type actuator runs smoothly with fast response, suitable for a variety of industrial automation scenarios.

HiFluid offers both normally-open (NO) and normally-closed (NC) versions to match system logic. Actuators are available in light- and heavy-duty versions to accommodate different driving pressures.

#### Features

- Actuators are made of anodized aluminum, which provides good corrosion resistance.
- Mechanical position indicator provided as standard; optional limit switches are available for remote monitoring or system integration.
- Spring-return design as standard; double-acting construction available according to application requirements.
- Except for the actuator, all performance characteristics are identical to the hand-operated needle valves.



#### Needle Valves

Hand-Operated

Actuator

Check Valves

Relief Valves

Filters

Fittings

Adapters and

Couplings

# Low Pressure—Needle Valves (Hand-Operated)

## Selection Example

15		V1		P6		-B	
Pressure Rating		Body Pattern		Connection Size		Options	
15	15,000psi	V1	2-Way Straight	B4	BSP1/4"	B	Cryogenic Packing -73°C (-100°F)
		V2	2-Way Angle	P4	NPT1/4"	GY	Graphite Braided Yarn Packing 426°C (799°F)
		V3	3-Way, 2 on Pressure	B6	BSP3/8"	HT	High Temperature Option 649°C (1200°F)
		V4	3-Way, 1 on Pressure	P6	NPT3/8"	LT	Low Temperature Option -253°C (-423°F)
		V5	3-Way, 2-Stem Manifold	B8	BSP1/2"	TG	Teflon Glass Packing 315°C (600°F)
				P8	NPT1/2"	H2	Hydrogen Service
				B12	BSP3/4"	O2	Oxygen Service
				P12	NPT3/4"	R	Non-Rotating Regulating Stem
				B16	BSP1"		
				P16	NPT1"		

-  Low Pressure
- Needle Valves
- Hand-Operated
- Actuator
- Check Valves
- Relief Valves
- Filters
- Fittings
- Adapters and Couplings

## Flow Coefficient

O.D. Size in. (mm)	Connection Type	Orifice Size in. (mm)	Rated (Cv*)	Pressure Rating @R.T. (psi (bar))**
1/4 (6.35)	B4/P4	0.201 (5.1)	0.75	15,000 (1,034)
3/8 (9.53)	B6/P6	0.312 (7.9)	1.3	15,000 (1,034)
1/2 (12.7)	B8/P8	0.312 (7.9)	1.3	15,000 (1,034)
3/4 (19.05)	B12/P12	0.687 (17.4)	5.20	15,000 (1,034)
1 (25.4)	B16/P16	0.687 (17.4)	5.20	15,000 (1,034)

## Flow Curve

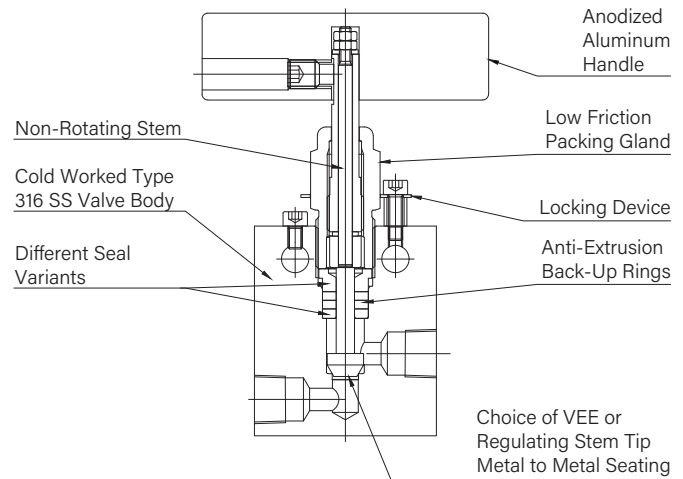
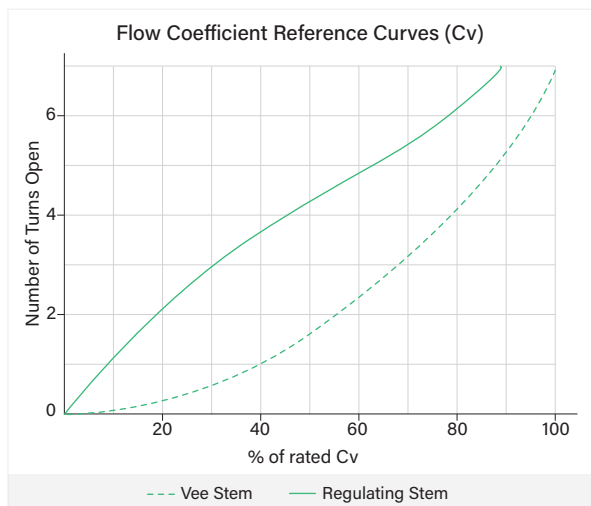

\* Cv values shown are for 2-way straight pattern vee stem valves. For 2-way angle patterns, increase the Cv value by 50%.

\*\* For the pressure-temperature relationship, refer to the guidance in the "Technical Information" section.

# Low Pressure—Needle Valves (Hand-Operated)

**Dimensions**



Valve Pattern	Type	Conn- ection Type	Orifice in. (mm)	Dimensions in. (mm)										Valve Panel Hole	Block Thick- ness
				A	B	C	D	E	F	H	I	J	K		
<b>2-Way Straight</b>															
	15V1B4	B4F	0.201 (5.1)	4.61 (117)	2.01 (51)	1.62 (41.1)	0.22 (5.5)	0.37 (9.5)	1.24 (31.5)	2.95 (75)	1.19 (30.2)	2.01 (51)		0.75 (19.1)	0.79 (20)
	15V1P4	P4F													
	15V1B6	B6F	0.312 (7.9)	6.3 (160)	2.88 (73.2)	2.38 (60.5)	0.37 (9.5)	0.45 (11.5)	1.38 (35)	1.38 (35)	1.75 (44.5)	2.50 (63.5)		1.00 (25.4)	1.02 (26)
	15V1P6	P6F													
	15V1B8	B8F	0.312 (7.9)	6.496 (165)	3.11 (79)	2.36 (60)	0.37 (9.5)	0.45 (11.5)	1.38 (35)	3.94 (100)	1.73 (44)	2.64 (67)		1.00 (25.4)	1.54 (39)
	15V1P8	P8F													
	15V1B12	B12F	0.687 (17.4)	9.00 (228)	4.65 (118)	3.75 (95.3)	0.53 (13.5)	1.13 (28.7)	2.50 (63.5)	10.31 (262)	2.81 (71.4)	4.13 (105)		1.62 (41.1)	1.77 (45)
	15V1P12	P12F													
	15V1B16	B16F	0.687 (17.4)	9.00 (228)	4.65 (118)	3.75 (95.3)	0.53 (13.5)	1.13 (28.7)	2.50 (63.5)	10.31 (262)	2.81 (71.4)	4.13 (105)		1.62 (41.1)	1.77 (45)
	15V1P16	P16F													
<b>2-Way Angle</b>															
	15V2B4	B4F	0.201 (5.1)	5.00 (127)	2.43 (61.7)	1.19 (30.2)	0.22 (5.6)	0.37 (9.5)	1.24 (31.5)	2.95 (75)	1.00 (25.4)	2.01 (51)		0.75 (19.1)	0.79 (20)
	15V2P4	P4F													
	15V2B6	B6F	0.312 (7.9)	6.77 (172)	3.38 (85.9)	1.75 (44.5)	0.37 (9.5)	0.45 (11.5)	1.38 (35)	3.94 (100)	1.25 (31.8)	2.50 (63.5)		1.00 (25.4)	1.02 (26)
	15V2P6	P6F													
	15V2B8	B8F	0.312 (7.9)	6.464 (164)	3.11 (79)	1.73 (44)	0.37 (9.5)	0.45 (11.5)	1.38 (35)	3.94 (100)	1.32 (33.5)	2.64 (67)		1.00 (25.4)	1.54 (39)
	15V2P8	P8F													
	15V2B12	B12F	0.687 (17.4)	9.00 (228)	4.65 (118)	2.81 (71.4)	0.53 (13.5)	1.13 (28.7)	2.50 (63.5)	10.31 (262)	2.07 (52.5)	4.13 (105)		1.62 (41.1)	1.77 (45)
	15V2P12	P12F													
	15V2B16	B16F	0.687 (17.4)	9.00 (228)	4.65 (118)	2.81 (71.4)	0.53 (13.5)	1.13 (28.7)	2.50 (63.5)	10.31 (262)	2.07 (52.5)	4.13 (105)		1.62 (41.1)	1.77 (45)
	15V2P16	P16F													

Note: Dimensions are for reference only; contact HiFluid for further requirements.

# Low Pressure—Needle Valves (Hand-Operated)

**Dimensions**



Valve Pattern	Type	Conn- ection Type	Orifice in. (mm)	Dimensions in. (mm)										Valve Panel Hole	Block Thick- ness
				A	B	C	D	E	F	H	I	J	K		
<b>3-Way, 2 on Pressure</b>															
	15V3B4	B4F	0.201 (5.1)	5.10 (129)	2.62 (66.5)	1.62 (41.1)	0.22 (5.5)	0.37 (9.5)	1.24 (31.5)	2.95 (75)	1.00 (25.4)	2.01 (51)	1.19 (30.2)	0.75 (19.1)	0.79 (20)
	15V3P4	P4F													
	15V3B6	B6F	0.312 (7.9)	6.62 (168)	3.62 (92)	2.38 (60.5)	0.37 (9.5)	0.45 (11.5)	1.38 (35)	3.94 (100)	1.25 (31.8)	2.50 (63.5)	1.75 (44.5)	1.00 (25.4)	1.02 (26)
	15V3P6	P6F													
	15V3B8	B8F	0.312 (7.9)	7.25 (184)	3.90 (99)	2.38 (60.5)	0.37 (9.5)	0.45 (11.5)	1.38 (35)	3.94 (100)	1.32 (33.5)	2.64 (67)	1.73 (44)	1.00 (25.4)	1.54 (39)
	15V3P8	P8F													
	15V3B12	B12F	0.687 (17.4)	10.16 (258)	5.83 (148)	2.81 (71.4)	0.53 (13.5)	1.13 (28.7)	2.50 (63.5)	10.31 (262)	2.07 (52.5)	4.13 (105)	2.81 (71.4)	1.62 (41.1)	1.62 (41.1)
	15V3P12	P12F													
	15V3B16	B16F	0.687 (17.4)	10.32 (262)	6.00 (152)	2.81 (71.4)	0.53 (13.5)	1.13 (28.7)	2.50 (63.5)	10.31 (262)	2.07 (52.5)	4.13 (105)	2.81 (71.4)	1.62 (41.1)	1.77 (45)
	15V3P16	P16F													
<b>3-Way, 1 on Pressure</b>															
	15V4B4	B4F	0.201 (5.1)	5.00 (127)	2.43 (61.7)	1.62 (41.1)	0.22 (5.6)	0.37 (9.5)	1.24 (31.5)	2.95 (75)	1.00 (25.4)	2.01 (51)		0.75 (19.1)	0.79 (20)
	15V4P4	P4F													
	15V4B6	B6F	0.312 (7.9)	6.38 (162)	3.39 (86)	2.38 (60.5)	0.37 (9.5)	0.45 (11.5)	1.38 (35)	3.94 (100)	1.25 (31.8)	2.50 (63.5)		1.00 (25.4)	1.02 (26)
	15V2P6	P6F													
	15V4B8	B8F	0.312 (7.9)	6.89 (175)	3.54 (90)	2.38 (60.5)	0.37 (9.5)	0.45 (11.5)	1.38 (35)	3.94 (100)	1.32 (33.5)	2.64 (67)		1.00 (25.4)	1.54 (39)
	15V4P8	P8F													
	15V4B12	B12F	0.687 (17.4)	9.76 (248)	5.44 (138)	2.81 (71.4)	0.53 (13.5)	1.13 (28.7)	2.50 (63.5)	10.31 (262)	2.07 (52.5)	4.13 (105)		1.62 (41.1)	1.77 (45)
	15V4P12	P12F													
	15V4B16	B16F	0.687 (17.4)	9.76 (248)	5.44 (138)	2.81 (71.4)	0.53 (13.5)	1.13 (28.7)	2.50 (63.5)	10.31 (262)	2.07 (52.5)	4.13 (105)		1.62 (41.1)	1.77 (45)
	15V4P16	P16F													

Note: Dimensions are for reference only; contact HiFluid for further requirements.

# Low Pressure—Needle Valves (Hand-Operated)

## Dimensions



Valve Pattern	Type	Conn- ection Type	Orifice in. (mm)	Dimensions in. (mm)										Valve Panel Hole	Block Thick- ness
				A	B	C	D	E	F	H	I	J	K		
<b>3-Way, 2-Stem Manifold</b>															
	15V5B4	B4F	0.201 (5.1)	9.06 (230)	4.17 (106)	2.09 (53)	0.22 (5.5)	0.37 (9.5)	1.24 (31.5)	2.95 (75)	1.00 (25.4)	2.01 (51)	1.19 (30.2)	0.75 (19.1)	0.79 (20)
	15V5P4	P4F													
	15V5B6	B6F	0.312 (7.9)	11.03 (280)	5.20 (132)	2.60 (66)	0.37 (9.5)	0.45 (11.5)	1.38 (35)	3.94 (100)	1.25 (31.8)	2.50 (63.5)	1.75 (44.5)	1.00 (25.4)	1.02 (26)
	15V5P6	P6F													
	15V5B8	B8F	0.312 (7.9)	11.34 (288)	5.52 (140)	2.76 (70)	0.37 (9.5)	0.45 (11.5)	1.38 (35)	3.94 (100)	1.32 (33.5)	2.64 (67)	1.73 (44)	1.00 (25.4)	1.54 (39)
	15V5P8	P8F													
	15V5B12	B12F	0.687 (17.4)	16.77 (426)	8.31 (211)	4.18 (106)	0.53 (13.5)	1.13 (28.7)	2.50 (63.5)	10.31 (262)	2.07 (52.5)	4.13 (105)	2.81 (71.4)	1.62 (41.1)	1.62 (41.1)
	15V5P12	P12F													
	15V5B16	B16F	0.687 (17.4)	16.77 (426)	8.31 (211)	4.18 (106)	0.53 (13.5)	1.13 (28.7)	2.50 (63.5)	10.31 (262)	2.07 (52.5)	4.13 (105)	2.81 (71.4)	1.62 (41.1)	1.77 (45)
	15V5P16	P16F													

Note: Dimensions are for reference only; contact HiFluid for further requirements.

Pressure to 15,000psi (1,034bar)

# Low Pressure—Actuator Needle Valves

HIFLUID

## Selection Example

15		V1		B6		-HNC		-GY	
Pressure Rating		Body Pattern		Connection Size		Actuator Type		Options	
15	15,000psi	V1	2-Way Straight	B4	BSP1/4"	MNO	Light-Duty NO	B	Cryogenic Packing -73°C (-100°F)
		V2	2-Way Angle	P4	NPT1/4"	HNO	Heavy-Duty NO	GY	Graphite Braided Yarn Packing 426°C (799°F)
				B6	BSP3/8"	MNC	Light-Duty NC	HT	High Temperature Option 649°C (1200°F)
				P6	NPT3/8"	HNC	Heavy-Duty NC	LT	Low Temperature Option -253°C (-423°F)
				B8	BSP1/2"	MDA	Light-Duty DA	TG	Teflon Glass Packing 315°C (600°F)
				P8	NPT1/2"	HDA	Heavy-Duty DA	H2	Hydrogen Service
				B12	BSP3/4"			O2	Oxygen Service
				P12	NPT3/4"				
				B16	BSP1"				
				P16	NPT1"				

-  Low Pressure
- Needle Valves
- Hand-operated
- Actuator
- Normally-Open
- Normally-Closed
- Double-Acting
- Check Valves
- Relief Valves
- Filters
- Fittings
- Adapters and Couplings

Note: For working pressure, please see "Technical Data".

Pressure to 15,000psi (1,034bar)

# Low Pressure—Actuator Needle Valves—Normally-Open

**HIFLUID**

## Dimensions

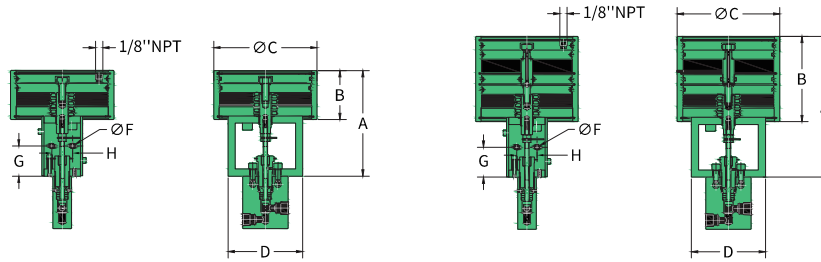

- Needle Valves
- Hand-Operated
- Actuator
- Normally-Open
- Normally-Closed
- Double-Acting
- Check Valves
- Relief Valves
- Filters
- Fittings
- Adapters and Couplings

Actuator Type	Suffix	Piston Area in. <sup>2</sup> (mm <sup>2</sup> )	Dimensions in. (mm)						
			A	B	C	D	F	G	H
Light Duty	4;6;8 - MNO	19.6 (12.645)	5.8 (147.3)	2.68 (68)	5.67 (144)	4.09 (104)	0.28 (7)	1.65 (42)	1.13 (28.8)
Heavy Duty	4;6;8 - HNO	39.2 (25.290)	7.77 (197.3)	4.69 (119)	5.67 (144)	4.09 (104)	0.28 (7)	1.65 (42)	1.13 (28.8)
Heavy Duty	12;16 - HNO	39.2 (25.290)	8.58 (218)	4.72 (120)	5.67 (144)	4.09 (104)	0.28 (7)	2.55 (64.7)	1.13 (28.8)

## Technical Data

Pressure Rating	Connection Type	Air Actuator		Air pressure required to close Valve at: System Pressure ksi (bar)								Max. Pressure psi (bar)	Stem Travel in. (mm)	Flow Coefficient Cv*
		Type	Suffix	1-3 (68-207)	4 (275)	6 (414)	8 (551)	10 (689)	12 (827)	14 (965)	15 (1,034)			
15	B4F P4F	Light Duty	-MNO	40 (2.8)	40 (2.8)	40 (2.8)	40 (2.8)	50 (3.5)	60 (4.2)	70 (4.9)	75 (5.3)	15,000 (1,034)	0.25 (6.4)	0.75
		Heavy Duty	-HNO	20 (1.4)	20 (1.4)	20 (1.4)	20 (1.4)	25 (1.7)	30 (2.1)	35 (2.4)	38 (2.6)	15,000 (1,034)		
	B6F P6F	Light Duty	-MNO	60 (4.2)	60 (4.2)	65 (4.5)	80 (5.6)	100 (6.9)				10,000 (689)	0.25 (6.4)	1.30
		Heavy Duty	-HNO	30 (2.1)	30 (2.1)	30 (2.1)	40 (2.8)	50 (3.5)	55 (3.8)	60 (4.2)	65 (4.5)	15,000 (1,034)		
	B8F P8F	Light Duty	-MNO	60 (4.2)	60 (4.2)	65 (4.5)	80 (5.6)	100 (6.9)				10,000 (689)	0.38 (9.7)	1.30
		Heavy Duty	-HNO	30 (2.1)	30 (2.1)	30 (2.1)	40 (2.8)	50 (3.5)	55 (3.8)	60 (4.2)	65 (4.5)	15,000 (1,034)		
	B12F P12F	Heavy Duty	-HNO	50 (3.5)	50 (3.5)	70 (4.9)	100 (6.9)					8,000 (551)	0.44 (11.2)	5.20
	B16F P16F	Heavy Duty	-HNO	50 (3.5)	50 (3.5)	70 (4.9)	100 (6.9)					8,000 (551)	0.56 (14.2)	

\* Cv values are for straight pattern valves, increase this value by 50% for angle pattern valves.

Pressure to 15,000psi (1,034bar)

# Low Pressure—Actuator Needle Valves—Normally-Closed

HIFLUID

## Dimensions

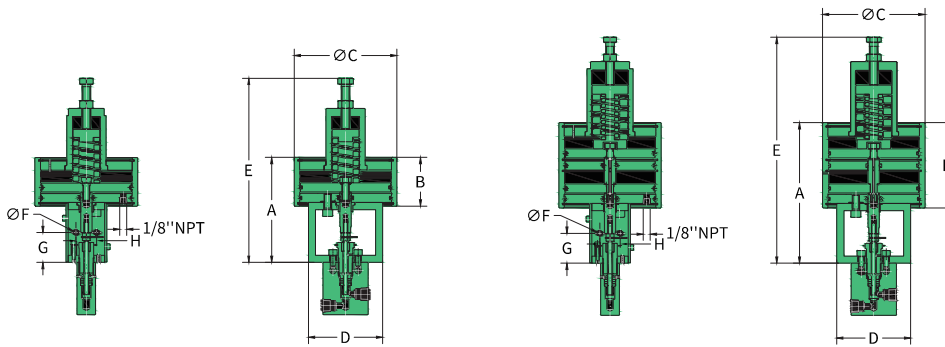

Actuator Type	Suffix	Piston Area in. <sup>2</sup> (mm <sup>2</sup> )	Dimensions in. (mm)							
			A	B	C	D	E*	F	G	H
Light Duty	4;6;8 - MNC	19.6 (12.645)	5.79 (147.3)	2.70 (68.5)	5.67 (144)	4.09 (104)	9.97 (253.3)	0.28 (7)	1.65 (42)	1.13 (28.8)
Heavy Duty	4;6;8 - HNC	39.2 (25.290)	7.78 (197.8)	4.72 (119.9)	5.67 (144)	4.09 (104)	12.51 (317.8)	0.28 (7)	1.65 (42)	1.13 (28.8)
Heavy Duty	12;16 - HNC	39.2 (25.290)	8.58 (217.9)	4.72 (119.9)	5.67 (144)	4.09 (104)	13.39 (340)	0.28 (7)	2.55 (64.7)	1.13 (28.8)

\* E dimension is an approximation only.



- Needle Valves
- Hand-Operated
- Actuator
- Normally-Open
- Normally-Closed
- Double-Acting
- Check Valves
- Relief Valves
- Filters
- Fittings
- Adapters and Couplings

# Low Pressure—Actuator Needle Valves—Normally-Closed

## Technical Data

Pressure Rating	Connection Type	Air Actuator			Air pressure required to open Valve at: System Pressure ksi (bar)						Max. Pressure psi (bar)	Flow Coefficient Cv*	
		Type	Suffix	Data	6 (414)	8 (551)	10 (689)	12 (827)	14 (965)	15 (1,034)			
15	B4F P4F	Light Duty	-MNC	Air Pressure psi (bar)	65 (4.5)	75 (5.2)	85 (5.9)	95 (6.6)	95 (6.6)	95 (6.6)	15,000 (1,034)	0.31 - 0.22	
				Spring Pre-Compression in. (mm)	0.19 (4.8)	0.25 (6.4)	0.31 (7.9)	0.38 (9.7)	0.44 (11.2)	0.5 (12.7)			
				Stem Travel in. (mm)	0.25 (6.4)	0.25 (6.4)	0.25 (6.4)	0.25 (6.4)	0.25 (6.4)	0.19 (4.8)			
		Heavy Duty	-HNC	Air Pressure psi (bar)	35 (2.4)	40 (2.8)	45 (3.1)	50 (3.5)	50 (3.5)	50 (3.5)			15,000 (1,034)
				Spring Pre-Compression in. (mm)	0.19 (4.8)	0.25 (6.4)	0.31 (7.9)	0.38 (9.7)	0.44 (11.2)	0.5 (12.7)			
				Stem Travel in. (mm)	0.25 (6.4)	0.25 (6.4)	0.25 (6.4)	0.25 (6.4)	0.19 (4.8)	0.12 (3)			
	B6F P6F	Light Duty	-MNC	Air Pressure psi (bar)	90 (6.2)	95 (6.6)	95 (6.6)				9,800 (676)	0.75 - 0.57	
				Spring Pre-Compression in. (mm)	0.34 (8.6)	0.47 (11.9)	0.56 (14.2)						
				Stem Travel in. (mm)	0.25 (6.4)	0.25 (6.4)	0.25 (6.4)						
		Heavy Duty	-HNC	Air Pressure psi (bar)	35 (2.4)	40 (2.8)	45 (3.1)	50 (3.5)	50 (3.5)	50 (3.5)			15,000 (1,034)
				Spring Pre-Compression in. (mm)	0.19 (4.8)	0.25 (6.4)	0.31 (7.9)	0.38 (9.7)	0.44 (11.2)	0.5 (12.7)			
				Stem Travel in. (mm)	0.25 (6.4)	0.25 (6.4)	0.25 (6.4)	0.25 (6.4)	0.19 (4.8)	0.12 (3)			
B8F P8F	Light Duty	-MNC	Air Pressure psi (bar)	90 (6.2)	95 (6.6)	95 (6.6)				9,800 (676)	1.29 - 0.53		
			Spring Pre-Compression in. (mm)	0.34 (8.6)	0.47 (11.9)	0.56 (14.2)							
			Stem Travel in. (mm)	0.25 (6.4)	0.15 (3.8)	0.06 (1.5)							
	Heavy Duty	-HNC	Air Pressure psi (bar)	55 (3.8)	65 (4.5)	70 (4.9)	75 (5.2)	75 (5.2)	75 (5.2)			15,000 (1,034)	
			Spring Pre-Compression in. (mm)	0.22 (5.6)	0.28 (7.1)	0.34 (8.6)	0.44 (11.2)	0.5 (12.7)	0.53 (13.5)				
			Stem Travel in. (mm)	0.25 (6.4)	0.25 (6.4)	0.25 (6.4)	0.19 (4.8)	0.12 (3)	0.06 (1.5)				
B12F P12F	Heavy Duty	-HNC	Air Pressure psi(bar)	75 (5.2)						6,100 (421)	0.80 - 0.78		
			Spring Pre-Compression in. (mm)	0.56 (14.2)									
			Stem Travel in. (mm)	0.06 (1.5)									
B16F P16F	Heavy Duty	-HNC	Air Pressure psi(bar)	75 (5.2)						6,100 (421)	2.73 - 0.15		
			Spring Pre-Compression in. (mm)	0.56 (14.2)									
			Stem Travel in. (mm)	0.06 (1.5)									

\* Cv values are for straight pattern valves, increase this value by 50% for angle pattern valves.  
Cv values vary due to compression of actuator spring, and are adjusted based on system pressure. Values shown are for maximum to minimum stem travel position.

Needle Valves  
Hand-Operated  
Actuator  
Normally-Open  
Normally-Closed  
Double-Acting  
Check Valves  
Relief Valves  
Filters  
Fittings  
Adapters and Couplings

Pressure to 15,000psi (1,034bar)

# Low Pressure—Actuator Needle Valves—Double-Acting

HIFLUID

## Dimensions

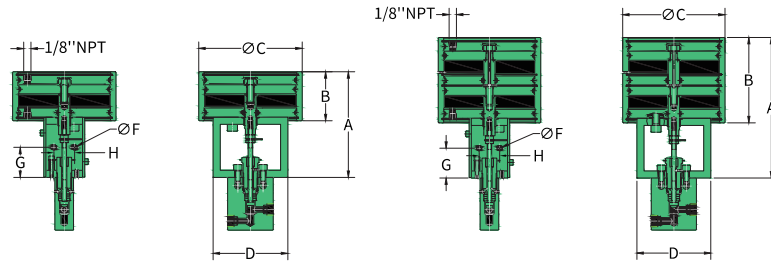

Needle Valves  
Hand-Operated  
Actuator  
Normally-Open  
Normally-Open  
Double-Acting  
Check Valves  
Relief Valves  
Filters  
Fittings  
Adapters and Couplings

Actuator Type	Suffix	Piston Area in. <sup>2</sup> (mm <sup>2</sup> )	Dimensions in. (mm)						
			A	B	C	D	F	G	H
Light Duty	4;6;8-MDA	19.6 (12.645)	5.8 (147.3)	2.68 (68)	5.67 (144)	4.09 (104)	0.28 (7)	1.65 (42)	1.13 (28.8)
Heavy Duty	4;6;8-HDA	39.2 (25.290)	7.77 (197.3)	4.69 (119)	5.67 (144)	4.09 (104)	0.28 (7)	1.65 (42)	1.13 (28.8)
Heavy Duty	12;16-HDA	39.2 (25.290)	8.58 (217.9)	4.72 (120)	5.67 (144)	4.09 (104)	0.28 (7)	2.55 (64.7)	1.13 (28.8)

## Technical Data

Pressure Rating	Connection Type	Air Actuator		Air pressure required to close Valve at: System Pressure ksi (bar)								Max. Pressure psi (bar)	Stem Travel in. (mm)	Flow Coefficient Cv*
		Type	Suffix	1-3 (68-207)	4 (275)	6 (414)	8 (551)	10 (689)	12 (827)	14 (965)	15 (1,034)			
15	B4F P4F	Light Duty	-MDA	40 (2.8)	40 (2.8)	40 (2.8)	40 (2.8)	50 (3.5)	60 (4.2)	70 (4.9)	75 (5.3)	15,000 (1,034)	0.25 (6.4)	0.75
		Heavy Duty	-HDA	20 (1.4)	20 (1.4)	20 (1.4)	20 (1.4)	25 (1.7)	30 (2.1)	35 (2.4)	38 (2.6)	15,000 (1,034)		
	B6F P6F	Light Duty	-MDA	60 (4.2)	60 (4.2)	65 (4.5)	80 (5.6)	100 (6.9)				10,000 (689)	0.25 (6.4)	1.3
		Heavy Duty	-HDA	30 (2.1)	30 (2.1)	30 (2.1)	40 (2.8)	50 (3.5)	55 (3.8)	60 (4.2)	65 (4.5)	15,000 (1,034)		
	B8F P8F	Light Duty	-MDA	60 (4.2)	60 (4.2)	65 (4.5)	80 (5.6)	100 (6.9)				10,000 (689)	0.38 (9.7)	1.3
		Heavy Duty	-HDA	30 (2.1)	30 (2.1)	30 (2.1)	40 (2.8)	50 (3.5)	55 (3.8)	60 (4.2)	65 (4.5)	15,000 (1,034)		
	B12F P12F	Heavy Duty	-HDA	50 (3.5)	50 (3.5)	70 (4.9)	100 (6.9)					8,000 (551)	0.44 (11.2)	5.2
	B16F P16F	Heavy Duty	-HDA	50 (3.5)	50 (3.5)	70 (4.9)	100 (6.9)					8,000 (551)	0.56 (14.2)	5.2

\* Cv values are for straight pattern valves, increase this value by 50% for angle pattern valves.



## O-Ring Check Valves

An O-ring check valve uses an elastomer O-ring to achieve one-way flow control. The pre-compressed elastic seal prevents reverse flow, delivering tight shutoff and sensitive opening—particularly suitable for medium-pressure gas and liquid control systems.

The standard O-ring check valves seal with FKM, operate from -20°C to 200°C (-4°F to 392°F), The opening pressure of the O-ring check valves is approx. 20psi (1.38bar),  $\pm 30\%$ .

## Ball Check Valves

A ball check valve controls one-way flow using a spherical element. When differential pressure drops below the set opening pressure, the valve automatically closes to prevent backflow—ideal where sealing requirements are relatively lower, but backflow must be avoided.

HiFluid ball check valves are suitable for service up to 349°C (660°F), The opening pressure of the ball check valves is approx. 20psi (1.38bar),  $\pm 30\%$ .



Low Pressure

Needle Valves

**Check Valves**

O-Ring Check

Ball Check

Relief Valves

Filters

Fittings

Adapters and

Couplings

Pressure to 15,000psi (1,034bar)

# Low Pressure—O-Ring Check Valves

**HIFLUID**



- Needle Valves
- Check Valves
- O-Ring Check**
- Ball Check
- Relief Valves
- Filters
- Fittings
- Adapters and Couplings

## Selection Example

15		V61		P8		-TO			
Pressure Rating		Component Type		Connection Size		Options			
15	15,000psi	V61	O-Ring Check Valve	P4	NPT1/4"	BO	Buna-N O-ring -29°C to 121°C (-20°F to 250°F)		
				P6	NPT3/8"	EO	EPDM O-ring -40°C to 130°C (-40°F to 266°F)		
				P8	NPT1/2"	KO	FFKM O-ring -18°C to 260°C (0°F to 500°F)		
				P12	NPT3/4"	LTTO	PTFE O-ring with Low Temp. Spring -252°C (-423°F)		
				P16	NPT1"	TO	PTFE O-ring -73°C to 204°C (-100°F to 400°F)		

## Dimensions

Valve Pattern	Type	Connection Type	Max. Pressure psi (bar)	Orifice in. (mm)	Rated (Cv)	Dimensions in. (mm)			
						A	B	C (HEX.)	D (HEX.)
<b>O-Ring Check Valves</b>									
	15V61P4	P4F	15,000 (1,034)	0.106 (2.7)	0.28	0.86 (22)	0.86 (22)	0.86 (22)	2.91 (73.9)
	15V61P6	P6F	15,000 (1,034)	0.201 (5.1)	0.84	1.06 (27)	1.06 (27)	1.06 (27)	3.31 (84.1)
	15V61P8	P8F	15,000 (1,034)	0.307 (7.8)	2.30	1.42 (36)	1.42 (36)	1.42 (36)	4.29 (109)
	15V61P12	P12F	15,000 (1,034)	0.438 (11.1)	4.70	2.00 (50.8)	2.00 (50.8)	2.00 (50.8)	5.46 (138.7)
	15V61P16	P16F	15,000 (1,034)	0.562 (14.3)	7.40	2.00 (50.8)	2.00 (50.8)	2.00 (50.8)	6.57 (166.9)

Pressure to 15,000psi (1,034bar)

# Low Pressure—Ball Check Valves

HIFLUID

## Selection Example

15		V62		P8		-LTS	
Pressure Rating		Component Type		Connection Size		Options	
15	15,000psi	V62	Ball Check Valve	P4	NPT1/4"	LTS	Low Temperature Spring -252°C (-423°F)
				P6	NPT3/8"		
				P8	NPT1/2"		
				P12	NPT3/4"		
				P16	NPT1"		

-  Low Pressure
- Needle Valves
- Check Valves
  - O-Ring Check
  - Ball Check**
- Relief Valves
- Filters
- Fittings
- Adapters and Couplings

## Dimensions

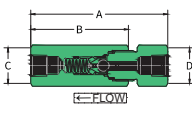
Valve Pattern	Type	Connection Type	Max. Pressure psi (bar)	Orifice in. (mm)	Rated (Cv)	Dimensions in. (mm)			
						A	B	C (HEX.)	D (HEX.)
<b>Ball Check Valves</b>									
	15V62P4	P4F	15,000 (1,034)	0.201 (5.1)	0.28	3.36 (85.3)	2.40 (61)	0.86 (22)	0.86 (22)
	15V62P6	P6F	15,000 (1,034)	0.312 (7.9)	0.84	3.94 (100)	2.95 (75)	1.41 (36)	1.41 (36)
	15V62P8	P8F	15,000 (1,034)	0.312 (7.9)	2.30	5.32 (135.7)	3.90 (99)	1.41 (36)	1.41 (36)
	15V62P12	P12F	15,000 (1,034)	0.685 (17.4)	4.70	6.29 (159.8)	4.88 (124)	2.00 (50.8)	2.00 (50.8)
	15V62P16	P16F	15,000 (1,034)	0.685 (17.4)	7.40	7.32 (186)	5.75 (146)	2.00 (50.8)	2.00 (50.8)



## Relief Valves

A relief valve is an adjustable pressure-safety device used in hydraulic or pneumatic systems to prevent overpressure and ensure safe, stable operation. When system pressure reaches the setpoint, the valve opens to discharge excess pressure, avoiding equipment damage and safety incidents.

HiFluid relief valves provide a 3/4" NPT outlet and modular construction; the seat, collar, and gland are individually replaceable for convenient maintenance and extended service life.

Standard design is hard-seat. A soft-seat option is available for improved sealing performance according to application needs.



- Needle Valves
- Check Valves
- Relief Valves**
- Filters
- Fittings
- Adapters and Couplings

### Selection Example

15		V7		P8		-S	
Pressure Rating		Component Type		Connection Size		Options	
5	5,000psi	V7	Relief Valve	P8	NPT1/2"	S	Soft Seat
10	10,000psi						
15	15,000psi						

### Dimensions

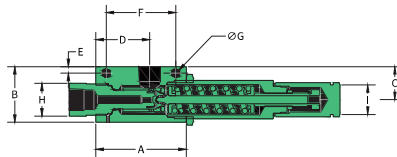

Type	Max. Pressure psi (bar)	Pressure Range min/max psi (bar)	Orifice in. (mm)	Inlet Connection Type	Outlet Connection Size	Dimensions in. (mm)										Block Thickness
						A	B	C	D	E	F	G	H (HEX.)	I (HEX.)		
5V7P8	5,000 (345)	3,000/5,000 (207/345)	0.312 (7.92)	P8F	NPT3/4"	3.25 (82.5)	2 (50.8)	1.19 (30.2)	1.94 (49.3)	0.25 (6.35)	2.5 (63.5)	0.28 (7.11)	1.18 (30)	1.06 (27)	1.5 (38)	
10V7P8	10,000 (689)	5,000/10,000 (345/689)	0.250 (6.35)	P8F	NPT3/4"	3.25 (82.5)	2 (50.8)	1.19 (30.2)	1.94 (49.3)	0.25 (6.35)	2.5 (63.5)	0.28 (7.11)	1.18 (30)	1.06 (27)	1.5 (38)	
15V7P8	15,000 (1,034)	10,000/15,000 (689/1,034)	0.188 (4.78)	P8F	NPT3/4"	3.25 (82.5)	2 (50.8)	1.19 (30.2)	1.94 (49.3)	0.25 (6.35)	2.5 (63.5)	0.28 (7.11)	1.18 (30)	1.06 (27)	1.5 (38)	

## Cup-Type Line Filters

Cup-Type Line Filters capture solid impurities to protect downstream systems. The cup element provides a larger filtration area. Standard ratings: 5µm, 30µm, 56µm, which can be flexibly selected according to different operating requirements.

Operating temperature range: -253°C to 349°C (-423°F to 660°F), suitable for filtration under both extreme cryogenic and high-temperature conditions.



Needle Valves

Check Valves

Relief Valves

**Filters**

Cup-Type Line

Angle

Fittings

Adapters and Couplings



## Angle Filters

Angle Filters capture solid impurities to protect downstream equipment. Compared with Cup-Type Line Filters, the angle design allows element replacement without dismantling piping, making maintenance more convenient. Standard ratings: 5µm, 30µm, 56µm, which can be flexibly selected according to different operating requirements.

Operating temperature range: -253°C to 349°C (-423°F to 660°F), suitable for filtration under both extreme cryogenic and high-temperature conditions.

# Low Pressure—Cup-Type Line Filters

## Selection Example

15		F62		P4		-5	
Pressure Rating		Component Type		Connection Size		Micron Size (µm)	
15	15,000psi	F62	Cup-Type Line Filters	P4	NPT1/4"	5	
				P6	NPT3/8"	30	
				P8	NPT1/2"	56	
				P12	NPT3/4"		
				P16	NPT1"		

-  Low Pressure
- Needle Valves
- Check Valves
- Relief Valves
- Filters**
- Cup-Type Line**
- Angle
- Fittings
- Adapters and Couplings

## Dimensions

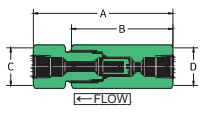
Filter Pattern	Type	Max. Pressure psi (bar)	Orifice in. (mm)	Micron Size (µm)	Connection Type	Filter Element Area in <sup>2</sup> (mm <sup>2</sup> )	Dimensions in. (mm)			
							A (in.)	B (in.)	C (HEX.)	D (HEX.)
<b>Cup-Type Line Filters</b>										
	15F62P4-5	15,000 (1,034)	0.201 (5.1)	5	P4F	0.82 (530)	3.25 (82.5)	2.36 (60)	0.86 (22)	0.86 (22)
	15F62P4-30			30						
	15F62P4-56			56						
	15F62P6-5	15,000 (1,034)	0.312 (7.9)	5	P6F	1.55 (1,000)	3.69 (93.8)	2.83 (71.8)	1.18 (30)	1.42 (36)
	15F62P6-30			30						
	15F62P6-56			56						
	15F62P8-5	15,000 (1,034)	0.312 (7.9)	5	P8F	1.55 (1,000)	4.42 (112.4)	3.35 (85)	1.42 (36)	1.42 (36)
	15F62P8-30			30						
	15F62P8-56			56						
	15F62P12-5	15,000 (1,034)	0.685 (17.4)	5	P12F	6.14 (3,960)	6.57 (167)	5.12 (130)	2.00 (50.8)	2.00 (50.8)
	15F62P12-30			30						
	15F62P12-56			56						
	15F62P16-5	15,000 (1,034)	0.685 (17.4)	5	P16F	6.14 (3,960)	6.77 (171.9)	5.31 (135)	2.00 (50.8)	2.00 (50.8)
	15F62P16-30			30						
	15F62P16-56			56						

- Note: 1. All fluids entering the high-pressure system should be thoroughly cleaned.  
 2. Filters are designed to remove small process particles.  
 3. The differential pressure across the filter element should not exceed 1,000 psi.

# Low Pressure—Angle Filters

## Selection Example

15		F63		P6		-5	
Pressure Rating		Component Type		Connection Size		Micron Size (µm)	
15	15,000psi	F63	Angle Filter	P4	NPT1/4"	5	
				P6	NPT3/8"	30	
				P8	NPT1/2"	56	
				P12	NPT3/4"		
				P16	NPT1"		

-  Low Pressure
- Needle Valves
- Check Valves
- Relief Valves
- Filters**
- Cup-Type Line
- Angle**
- Fittings
- Adapters and Couplings

## Dimensions

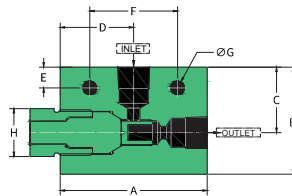

Type	Max. Pressure psi (bar)	Orifice in. (mm)	Connection Type	Micron Size (µm)	Filter Element Area in <sup>2</sup> (mm <sup>2</sup> )	Dimensions in. (mm)								Block Thickness
						A	B	C	D	E	F	G	H (HEX.)	
<b>Angel Filters</b>														
15F63P4-5	15,000 (1,034)	0.106 (2.7)	P4F	5	0.82 (530)	3.11 (79)	2.01 (51)	1.18 (30)	1.65 (42)	0.39 (10)	2.32 (59)	0.34 (8.5)	1.06 (27)	1.02 (26)
15F63P4-30				30										
15F63P4-56				56										
15F63P6-5	15,000 (1,034)	0.201 (5.1)	P6F	5	0.82 (530)	3.11 (79)	2.01 (51)	1.18 (30)	1.65 (42)	0.39 (10)	2.32 (59)	0.34 (8.5)	1.06 (27)	1.02 (26)
15F63P6-30				30										
15F63P6-56				56										
15F63P8-5	15,000 (1,034)	0.307 (7.8)	P8F	5	1.55 (1,000)	3.62 (92)	2.64 (67)	1.61 (41)	1.81 (46)	0.51 (13)	2.17 (55)	0.34 (8.5)	1.19 (30.2)	1.54 (39)
15F63P8-30				30										
15F63P8-56				56										
15F63P12-5	15,000 (1,034)	0.438 (11.1)	P12F	5	6.14 (3,960)	5.71 (145)	3.54 (90)	2.3 (58.4)	2.44 (62)	0.39 (10)	4.92 (125)	2.00 (50.8)	2.00 (50.8)	2.24 (57)
15F63P12-30				30										
15F63P12-56				56										
15F63P16-5	15,000 (1,034)	0.562 (14.3)	P16F	5	6.14 (3,960)	5.71 (145)	3.54 (90)	2.3 (58.4)	2.44 (62)	0.39 (10)	4.92 (125)	0.34 (8.5)	2.00 (50.8)	2.24 (57)
15F63P16-30				30										
15F63P16-56				56										

- Note: 1. All fluids entering the high-pressure system should be thoroughly cleaned.  
 2. Filters are designed to remove small process particles.  
 3. The differential pressure across the filter element should not exceed 1,000 psi.

### Straight Coupling, Elbow, Tee, Cross

HiFluid supplies a full range of straight coupling, elbow, tee, and cross fittings for multi-directional connections in low-pressure systems. All low-pressure fittings use the low-pressure connection standard to ensure reliable sealing and stable joints under low-pressure conditions.



- Needle Valves
- Check Valves
- Relief Valves
- Filters
- Fittings**
  - Straight Coupling
  - Elbow, Tee, Cross
- Adapters and Couplings

### Selection Example

15		F2		P12	
Pressure Rating		Body Pattern		Connection Size	
15	15,000psi	F1	Straight Coupling	P4	NPT1/4"
		F2	Elbow	P6	NPT3/8"
		F3	Tee	P8	NPT1/2"
		F4	Cross	P12	NPT3/4"
				P16	NPT1"

# Low Pressure—Straight Coupling, Elbow, Tee, Cross

**Dimensions**

-  Low Pressure
- Needle Valves
- Check Valves
- Relief Valves
- Filters
- Fittings
  - Straight Coupling
  - Elbow, Tee, Cross
- Adapters and Couplings

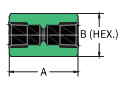
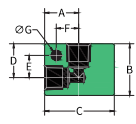
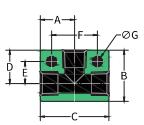
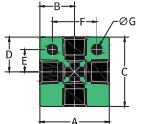
Body Pattern	Type	Connection Type	Orifice in. (mm)	Dimensions in. (mm)							Block Thickness
				A	B	C	D	E	F	G	
<b>Straight Coupling</b>											
	15F1P4	P4F	0.201 (5.1)	1.50 (38.1)	0.82 (21)						
	15F1P6	P6F	0.312 (7.9)	1.63 (41.3)	1.06 (27)						
	15F1P8	P8F	0.312 (7.9)	2.05 (52)	1.18 (30)						
	15F1P12	P12F	0.685 (17.4)	2.72 (69)	1.42 (36)						
	15F1P16	P16F	0.685 (17.4)	2.52 (64)	2.00 (50.8)						
<b>Elbow</b>											
	15F2P4	P4F	0.201 (5.1)	0.75 (19)	1.14 (29)	1.54 (39)	0.75 (19)	0.49 (12.5)	0.49 (12.5)	0.22 (5.5)	0.79 (20)
	15F2P6	P6F	0.312 (7.9)	1.00 (25.4)	1.50 (38)	2.01 (51)	1.00 (25.4)	0.63 (16)	0.63 (16)	0.26 (6.5)	1.02 (26)
	15F2P8	P8F	0.312 (7.9)	1.50 (38)	1.89 (48)	2.99 (76)	1.25 (31.8)	0.84 (21.3)	1.08 (27.5)	0.33 (8.5)	1.38 (35)
	15F2P12	P12F	0.685 (17.4)	1.50 (38)	2.24 (57)	2.99 (76)	1.50 (38)	1.00 (25.4)	1.00 (25.4)	0.35 (9)	1.38 (35)
	15F2P16	P16F	0.685 (17.4)	2.07 (52.5)	2.52 (64)	4.13 (105)	1.57 (40)	1.10 (28)	1.38 (35)	0.53 (13.5)	1.77 (45)
<b>Tee</b>											
	15F3P4	P4F	0.201 (5.1)	0.77 (19.5)	1.14 (29)	1.54 (39)	0.75 (19)	0.49 (12.5)	1.02 (26)	0.22 (5.5)	0.79 (20)
	15F3P6	P6F	0.312 (7.9)	1.00 (25.4)	1.50 (38)	2.01 (51)	1.00 (25.4)	0.63 (16)	1.26 (32)	0.26 (6.5)	1.02 (26)
	15F3P8	P8F	0.312 (7.9)	1.50 (38)	1.89 (48)	2.99 (76)	1.26 (32)	0.87 (22)	2.00 (51)	0.35 (9)	1.38 (35)
	15F3P12	P12F	0.685 (17.4)	1.50 (38)	2.20 (56)	2.99 (76)	1.50 (38)	1.00 (25.4)	2.00 (51)	0.35 (9)	1.38 (35)
	15F3P16	P16F	0.685 (17.4)	2.07 (52.5)	2.52 (64)	4.13 (105)	1.57 (40)	1.10 (28)	2.76 (70)	0.53 (13.5)	1.77 (45)
<b>Cross</b>											
	15F4P4	P4F	0.201 (5.1)	1.54 (39)	0.77 (19.5)	1.54 (39)	0.77 (19.5)	0.49 (12.5)	0.98 (25)	0.22 (5.5)	0.79 (20)
	15F4P6	P6F	0.312 (7.9)	2.01 (51)	1.00 (25.4)	2.01 (51)	1.00 (25.4)	0.63 (16)	1.26 (32)	0.26 (6.5)	1.02 (26)
	15F4P8	P8F	0.312 (7.9)	2.99 (76)	1.50 (38)	2.52 (64)	1.26 (32)	0.87 (22)	2.01 (51)	0.35 (9)	1.38 (35)
	15F4P12	P12F	0.685 (17.4)	2.99 (76)	1.50 (38)	2.99 (76)	1.50 (38)	1.00 (25.4)	2.01 (51)	0.35 (9)	1.38 (35)
	15F4P16	P16F	0.685 (17.4)	4.13 (105)	2.07 (52.5)	3.15 (80)	1.57 (40)	1.10 (28)	2.76 (70)	0.53 (13.5)	1.77 (45)



Low Pressure

Needle Valves

Check Valves

Relief Valves

Filters

Fittings

**Adapters and Couplings**

Adapters (Male to Female)

Couplings (Female to Female)

Adapters (Male to Male)



## Adapters (Male to Female)

HiFluid male to female adapters convert between different thread types or sizes, connecting a female thread to a male thread. Both ends may use different thread forms and sizes to meet installation needs under complex conditions.

The adapter's pressure rating is limited by the lower rating of the two ends. Naming rule: list the female size first, then the male size.

## Couplings (Female to Female)

HiFluid female to female couplings convert between different thread types or sizes, connecting two male threads. Both ends may use different thread forms and sizes to meet installation needs under complex conditions.

The pressure rating is limited by the lower rating of the two ends. Naming rule: under the same pressure rating, list the smaller size first; if ratings differ, list the lower-pressure first.



## Adapters (Male to Male)

HiFluid male to male adapters convert between different thread types or sizes, connecting two female threads. Both ends may use different thread forms and sizes to meet installation needs under complex conditions.

The pressure rating is limited by the lower rating of the two ends. Naming rule: under the same pressure rating, list the smaller size first; if ratings differ, list the lower-pressure first.

Pressure to 15,000psi (1,034bar)

# Low Pressure—Adapters (Male to Female)

**HIFLUID**

**Selection Example**

15		F51		P12		M4
Pressure Rating		Component Type		Female Size		Male Size
15	15,000psi	F51	Adapters (Male to Female)	P4	NPT1/4"	P4, B4, M4, H4, U4-1/4"
				P6	NPT3/8"	U5-5/16"
				P8	NPT1/2"	P6, B6, M6, H6, U6-3/8"
				P12	NPT3/4"	P8,B8-1/2"
				P16	NPT1"	M9, H9, U9-9/16"
				B4	BSP1/4"	P12, B12, M12-3/4"
				B6	BSP3/8"	P16, B16-1"
				B8	BSP1/2"	M16-1" (20 series)
				B12	BSP3/4"	M16H-1" (43 series)
				B16	BSP1"	M24-1-1/2"

-  Low Pressure
- Needle Valves
- Check Valves
- Relief Valves
- Filters
- Fittings
- Adapters and Couplings
- Adapters (Male to Female)
- Couplings (Female to Female)
- Adapters (Male to Male)

# Low Pressure—Adapters (Male to Female)

- Low Pressure
- Needle Valves
- Check Valves
- Relief Valves
- Filters
- Fittings
- Adapters and Couplings
- Adapters (Male to Female)
- Couplings (Female to Female)
- Adapters (Male to Male)

## Model Data

Male			Female				
O.D. Size in.	Connection Type	Max. Pressure psi (bar)*	15,000psi (1,034bar)				
			1/4" P4	3/8" P6	1/2" P8	3/4" P12	1" P16
Low-Pressure			Low-Pressure				
1/4	P4	15,000 (1,034)	15F51P4	15F51P6P4	15F51P8P4	15F51P12P4	15F51P16P4
3/8	P6	15,000 (1,034)	15F51P4P6	15F51P6	15F51P8P6	15F51P12P6	15F51P16P6
1/2	P8	15,000 (1,034)	15F51P4P8	15F51P6P8	15F51P8	15F51P12P8	15F51P16P8
3/4	P12	15,000 (1,034)	15F51P4P12	15F51P6P12	15F51P8P12	15F51P12	15F51P16P12
1	P16	15,000 (1,034)	15F51P4P16	15F51P6P16	15F51P8P16	15F51P12P16	15F51P16
1/4	B4	15,000 (1,034)	15F51P4B4	15F51P6B4	15F51P8B4	15F51P12B4	15F51P16B4
3/8	B6	15,000 (1,034)	15F51P4B6	15F51P6B6	15F51P8B6	15F51P12B6	15F51P16B6
1/2	B8	15,000 (1,034)	15F51P4B8	15F51P6B8	15F51P8B8	15F51P12B8	15F51P16B8
3/4	B12	15,000 (1,034)	15F51P4B12	15F51P6B12	15F51P8B12	15F51P12B12	15F51P16B12
1	B16	15,000 (1,034)	15F51P4B16	15F51P6B16	15F51P8B16	15F51P12B16	15F51P16B16
Medium-Pressure							
1-1/2	M24	15,000 (1,034)	15F51P4M24	15F51P6M24	15F51P8M24	15F51P12M24	15F51P16M24
1/4	M4	20,000 (1,379)	15F51P4M4	15F51P6M4	15F51P8M4	15F51P12M4	15F51P16M4
3/8	M6	20,000 (1,379)	15F51P4M6	15F51P6M6	15F51P8M6	15F51P12M6	15F51P16M6
9/16	M9	20,000 (1,379)	15F51P4M9	15F51P6M9	15F51P8M9	15F51P12M9	15F51P16M9
3/4	M12	20,000 (1,379)	15F51P4M12	15F51P6M12	15F51P8M12	15F51P12M12	15F51P16M12
1	M16	20,000 (1,379)	15F51P4M16	15F51P6M16	15F51P8M16	15F51P12M16	15F51P16M16
High-Pressure							
1	M16H	43,000 (2,965)	15F51P4M16H	15F51P6M16H	15F51P8M16H	15F51P12M16H	15F51P16M16H
1/4	H4	60,000 (4,137)	15F51P4H4	15F51P6H4	15F51P8H4	15F51P12H4	15F51P16H4
3/8	H6	60,000 (4,137)	15F51P4H6	15F51P6H6	15F51P8H6	15F51P12H6	15F51P16H6
9/16	H9	60,000 (4,137)	15F51P4H9	15F52P6H9	15F51P8H9	15F51P12H9	15F51P16H9
Ultra-High Pressure							
1/4	U4	100,000 (6,896)	15F51P4U4	15F51P6U4	15F51P8U4	15F51P12U4	15F51P16U4
3/8	U6	100,000 (6,896)	15F51P4U6	15F51P6U6	15F51P8U6	15F51P12U6	15F51P16U6
9/16	U9	100,000 (6,896)	15F51P4U9	15F51P6U9	15F51P8U9	15F51P12U9	15F51P16U9
5/16	U5	150,000 (10,344)	15F51P4U5	15F51P6U5	15F51P8U5	15F51P12U5	15F51P16U5

\* The pressure rating of any adapter is the value of the lowest rated connection in the fitting.

# Low Pressure—Adapters (Male to Female)



## Model Data

Male			Female				
O.D. Size in.	Connection Type	Max. Pressure psi (bar)*	15,000psi (1,034bar)				
			1/4" B4	3/8" B6	1/2" B8	3/4" B12	1" B16
Low-Pressure			Low-Pressure				
1/4	P4	15,000 (1,034)	15F51B4P4	15F51B6P4	15F51B8P4	15F51B12P4	15F51B16P4
3/8	P6	15,000 (1,034)	15F51B4P6	15F51B6P6	15F51B8P6	15F51B12P6	15F51B16P6
1/2	P8	15,000 (1,034)	15F51B4P8	15F51B6P8	15F51B8P8	15F51B12P8	15F51B16P8
3/4	P12	15,000 (1,034)	15F51B4P12	15F51B6P12	15F51B8P12	15F51B12P12	15F51B16P12
1	P16	15,000 (1,034)	15F51B4P16	15F51B6P16	15F51B8P16	15F51B12P16	15F51B16P16
1/4	B4	15,000 (1,034)	15F51B4	15F51B6B4	15F51B8B4	15F51B12B4	15F51B16B4
3/8	B6	15,000 (1,034)	15F51B4B6	15F51B6	15F51B8B6	15F51B12B6	15F51B16B6
1/2	B8	15,000 (1,034)	15F51B4B8	15F51B6B8	15F51B8	15F51B12B8	15F51B16B8
3/4	B12	15,000 (1,034)	15F51B4B12	15F51B6B12	15F51B8B12	15F51B12	15F51B16B12
1	B16	15,000 (1,034)	15F51B4B16	15F51B6B16	15F51B8B16	15F51B12B16	15F51B16
Medium-Pressure							
1-1/2	M24	15,000 (1,034)	15F51B4M24	15F51B6M24	15F51B8M24	15F51B12M24	15F51B16M24
1/4	M4	20,000 (1,379)	15F51B4M4	15F51B6M4	15F51B8M4	15F51B12M4	15F51B16M4
3/8	M6	20,000 (1,379)	15F51B4M6	15F51B6M6	15F51B8M6	15F51B12M6	15F51B16M6
9/16	M9	20,000 (1,379)	15F51B4M9	15F51B6M9	15F51B8M9	15F51B12M9	15F51B16M9
3/4	M12	20,000 (1,379)	15F51B4M12	15F51B6M12	15F51B8M12	15F51B12M12	15F51B16M12
1	M16	20,000 (1,379)	15F51B4M16	15F51B6M16	15F51B8M16	15F51B12M16	15F51B16M16
High-Pressure							
1	M16H	43,000 (2,965)	15F51B4M16H	15F51B6M16H	15F51B8M16H	15F51B12M16H	15F51B16M16H
1/4	H4	60,000 (4,137)	15F51B4H4	15F51B6H4	15F51B8H4	15F51B12H4	15F51B16H4
3/8	H6	60,000 (4,137)	15F51B4H6	15F51B6H6	15F51B8H6	15F51B12H6	15F51B16H6
9/16	H9	60,000 (4,137)	15F51B4H9	15F52B6H9	15F51B8H9	15F51B12H9	15F51B16H9
Ultra-High Pressure							
1/4	U4	100,000 (6,896)	15F51B4U4	15F51B6U4	15F51B8U4	15F51B12U4	15F51B16U4
3/8	U6	100,000 (6,896)	15F51B4U6	15F51B6U6	15F51B8U6	15F51B12U6	15F51B16U6
9/16	U9	100,000 (6,896)	15F51B4U9	15F51B6U9	15F51B8U9	15F51B12U9	15F51B16U9
5/16	U5	150,000 (10,344)	15F51B4U5	15F51B6U5	15F51B8U5	15F51B12U5	15F51B16U5

\* The pressure rating of any adapter is the value of the lowest rated connection in the fitting.

# Low Pressure—Adapters (Male to Female)

- Low Pressure
- Needle Valves
- Check Valves
- Relief Valves
- Filters
- Fittings
- Adapters and Couplings
- Adapters (Male to Female)
- Couplings (Female to Female)
- Adapters (Male to Male)

## Model Data

Male			Female					
O.D. Size in.	Connection Type	Max. Pressure psi (bar)*	15,000psi (1,034bar)	20,000psi (1,379bar)				
			1-1/2" M24	1/4" M4	3/8" M6	1/2" M9	3/4" M12	1" M16
Low-Pressure			Medium-Pressure					
1/4	P4	15,000 (1,034)	15F51M24P4	15F51M4P4	15F51M6P4	15F51M9P4	15F51M12P4	15F51M16P4
3/8	P6	15,000 (1,034)	15F51M24P6	15F51M4P6	15F51M6P6	15F51M9P6	15F51M12P6	15F51M16P6
1/2	P8	15,000 (1,034)	15F51M24P8	15F51M4P8	15F51M6P8	15F51M9P8	15F51M12P8	15F51M16P8
3/4	P12	15,000 (1,034)	15F51M24P12	15F51M4P12	15F51M6P12	15F51M9P12	15F51M12P12	15F51M16P12
1	P16	15,000 (1,034)	15F51M24P16	15F51M4P16	15F51M6P16	15F51M9P16	15F51M12P16	15F51M16P16
1/4	B4	15,000 (1,034)	15F51M24B4	15F51M4B4	15F51M6B4	15F51M9B4	15F51M12B4	15F51M16B4
3/8	B6	15,000 (1,034)	15F51M24B6	15F51M4B6	15F51M6B6	15F51M9B6	15F51M12B6	15F51M16B6
1/2	B8	15,000 (1,034)	15F51M24B8	15F51M4B8	15F51M6B8	15F51M9B8	15F51M12B8	15F51M16B8
3/4	B12	15,000 (1,034)	15F51M24B12	15F51M4B12	15F51M6B12	15F51M9B12	15F51M12B12	15F51M16B12
1	B16	15,000 (1,034)	15F51M24B16	15F51M4B16	15F51M6B16	15F51M9B16	15F51M12B16	15F51M16B16

Male			Female			
O.D. Size in.	Connection Type	Max. Pressure psi (bar)*	43,000psi (2,965bar)	60,000psi (4,137bar)		
			1" M16H	1/4" H4	3/8" H6	9/16" H9
Low-Pressure			High-Pressure			
1/4	P4	15,000 (1,034)	15F51M16HP4	15F51H4P4	15F51H6P4	15F51H9P4
3/8	P6	15,000 (1,034)	15F51M16HP6	15F51H4P6	15F51H6P6	15F51H9P6
1/2	P8	15,000 (1,034)	15F51M16HP8	15F51H4P8	15F51H6P8	15F51H9P8
3/4	P12	15,000 (1,034)	15F51M16HP12	15F51H4P12	15F51H6P12	15F51H9P12
1	P16	15,000 (1,034)	15F51M16HP16	15F51H4P16	15F51H6P16	15F51H9P16
1/4	B4	15,000 (1,034)	15F51M16HB4	15F51H4B4	15F51H6B4	15F51H9B4
3/8	B6	15,000 (1,034)	15F51M16HB6	15F51H4B6	15F51H6B6	15F51H9B6
1/2	B8	15,000 (1,034)	15F51M16HB8	15F51H4B8	15F51H6B8	15F51H9B8
3/4	B12	15,000 (1,034)	15F51M16HB12	15F51H4B12	15F51H6B12	15F51H9B12
1	B16	15,000 (1,034)	15F51M16HB16	15F51H4B16	15F51H6B16	15F51H9B16

\* The pressure rating of any adapter is the value of the lowest rated connection in the fitting.

# Low Pressure—Adapters (Male to Female)

Model Data

Male			Female			
O.D. Size in.	Connection Type	Max. Pressure psi (bar)*	100,000psi (6,896bar)			150,000psi (10,344bar)
			1/4" U4	3/8" U6	9/16" U9	5/16" U5
Low-Pressure			Ultra-High Pressure			
1/4	P4	15,000 (1,034)	15F51U4P4	15F51U6P4	15F51U9P4	15F51U5P4
3/8	P6	15,000 (1,034)	15F51U4P6	15F51U6P6	15F51U9P6	15F51U5P6
1/2	P8	15,000 (1,034)	15F51U4P8	15F51U6P8	15F51U9P8	15F51U5P8
3/4	P12	15,000 (1,034)	15F51U4P12	15F51U6P12	15F51U9P12	15F51U5P12
1	P16	15,000 (1,034)	15F51U4P16	15F51U6P16	15F51U9P16	15F51U5P16
1/4	B4	15,000 (1,034)	15F51U4B4	15F51U6B4	15F51U9B4	15F51U5B4
3/8	B6	15,000 (1,034)	15F51U4B6	15F51U6B6	15F51U9B6	15F51U5B6
1/2	B8	15,000 (1,034)	15F51U4B8	15F51U6B8	15F51U9B8	15F51U5B8
3/4	B12	15,000 (1,034)	15F51U4B12	15F51U6B12	15F51U9B12	15F51U5B12
1	B16	15,000 (1,034)	15F51U4B16	15F51U6B16	15F51U9B16	15F51U5B16

\* The pressure rating of any adapter is the value of the lowest rated connection in the fitting.

Low Pressure

- Needle Valves
- Check Valves
- Relief Valves
- Filters
- Fittings
- Adapters and Couplings
- Adapters (Male to Female)
- Couplings (Female to Female)
- Adapters (Male to Male)

Pressure to 15,000psi (1,034bar)

# Low Pressure—Couplings (Female to Female)

**HIFLUID**

## Selection Example

15		F52		P12		M4
Pressure Rating		Component Type		Female Size		Female Size
15	15,000psi	F52	Couplings (Female to Female)	P4	NPT1/4"	P4, B4, M4, H4, U4-1/4"
				P6	NPT3/8"	U5-5/16"
				P8	NPT1/2"	P6, B6, M6, H6, U6-3/8"
				P12	NPT3/4"	P8, B6-1/2"
				P16	NPT1"	M9, H9, U9-9/16"
				B4	BSP1/4"	P12, B12, M12-3/4"
				B6	BSP3/8"	P16, B16-1"
				B8	BSP1/2"	M16-1" (20 series)
				B12	BSP3/4"	M16H-1" (43 series)
				B16	BSP1"	M24-1-1/2"

-  Low Pressure
- Needle Valves
- Check Valves
- Relief Valves
- Filters
- Fittings
- Adapters and Couplings
- Adapters (Male to Female)
- Couplings (Female to Female)**
- Adapters (Male to Male)

# Low Pressure—Couplings (Female to Female)



**Model Data**

Female			Female				
O.D. Size in.	Connection Type	Max. Pressure psi (bar)*	15,000psi (1,034bar)				
			1/4" P4	3/8" P6	1/2" P8	3/4" P12	1" P16
Low-Pressure			Low-Pressure				
1/4	P4	15,000 (1,034)		15F52P4P6	15F52P4P8	15F52P4P12	15F52P4P16
3/8	P6	15,000 (1,034)			15F52P6P8	15F52P6P12	15F52P6P16
1/2	P8	15,000 (1,034)				15F52P8P12	15F52P8P16
3/4	P12	15,000 (1,034)					15F52P12P16
1	P16	15,000 (1,034)					
1/4	B4	15,000 (1,034)	15F52B4P4	15F52B4P6	15F52B4P8	15F52B4P12	15F52B4P16
3/8	B6	15,000 (1,034)	15F52P4B6	15F52B6P6	15F52B6P8	15F52B6P12	15F52B6P16
1/2	B8	15,000 (1,034)	15F52P4B8	15F52P6B8	15F52P8B8	15F52P8B12	15F52B8P16
3/4	B12	15,000 (1,034)	15F52P4B12	15F52P6B12	15F52P8B12	15F52P12B12	15F52B12P16
1	B16	15,000 (1,034)	15F52P4B16	15F52P6B16	15F52P8B16	15F52P12B16	15F52B16P16
Medium-Pressure							
1-1/2	M24	15,000 (1,034)	15F52P4M24	15F52P6M24	15F52P8M24	15F52P12M24	15F52P16M24
1/4	M4	20,000 (1,379)	15F52P4M4	15F52P6M4	15F52P8M4	15F52P12M4	15F52P16M4
3/8	M6	20,000 (1,379)	15F52P4M6	15F52P6M6	15F52P8M6	15F52P12M6	15F52P16M6
9/16	M9	20,000 (1,379)	15F52P4M9	15F52P6M9	15F52P8M9	15F52P12M9	15F52P16M9
3/4	M12	20,000 (1,379)	15F52P4M12	15F52P6M12	15F52P8M12	15F52P12M12	15F52P16M12
1	M16	20,000 (1,379)	15F52P4M16	15F52P6M16	15F52P8M16	15F52P12M16	15F52P16M16
High-Pressure							
1	M16H	43,000(2,965)	15F52P4M16H	15F52P6M16H	15F52P8M16H	15F52P12M16H	15F52P16M16H
1/4	H4	60,000 (4,137)	15F52P4H4	15F52P6H4	15F52P8H4	15F52P12H4	15F52P16H4
3/8	H6	60,000 (4,137)	15F52P4H6	15F52P6H6	15F52P8H6	15F52P12H6	15F52P16H6
9/16	H9	60,000 (4,137)	15F52P4H9	15F52P6H9	15F52P8H9	15F52P12H9	15F52P16H9
Ultra-High Pressure							
1/4	U4	100,000 (6,896)	15F52P4U4	15F52P6U4	15F52P8U4	15F52P12U4	15F52P16U4
3/8	U6	100,000 (6,896)	15F52P4U6	15F52P6U6	15F52P8U6	15F52P12U6	15F52P16U6
9/16	U9	100,000 (6,896)	15F52P4U9	15F52P6U9	15F52P8U9	15F52P12U9	15F52P16U9
5/16	U5	150,000 (10,344)	15F52P4U5	15F52P6U5	15F52P8U5	15F52P12U5	15F52P16U5

\* The pressure rating of any adapter is the value of the lowest rated connection in the fitting.

# Low Pressure—Couplings (Female to Female)

## Model Data

Female			Female				
O.D. Size in.	Connection Type	Max. Pressure psi (bar)*	15,000psi (1,034bar)				
			1/4" B4	3/8" B6	1/2" B8	3/4" B12	1" B16
Low-Pressure			Low-Pressure				
1/4	B4	15,000 (1,034)		15F52B4B6	15F52B4B8	15F52B4B12	15F52B4B16
3/8	B6	15,000 (1,034)			15F52B6B8	15F52B6B12	15F52B6B16
1/2	B8	15,000 (1,034)	15F52B4B8	15F52B6B8		15F52B8B12	15F52B8B16
3/4	B12	15,000 (1,034)	15F52B4B12	15F52B6B12	15F52B8B12		15F52B12B16
1	B16	15,000 (1,034)	15F52B4B16	15F52B6B16	15F52B8B16	15F52B12B16	
Medium-Pressure							
1-1/2	M24	15,000 (1,034)	15F52B4M24	15F52B6M24	15F52B8M24	15F52B12M24	15F52B16M24
1/4	M4	20,000 (1,379)	15F52B4M4	15F52B6M4	15F52B8M4	15F52B12M4	15F52B16M4
3/8	M6	20,000 (1,379)	15F52B4M6	15F52B6M6	15F52B8M6	15F52B12M6	15F52B16M6
9/16	M9	20,000 (1,379)	15F52B4M9	15F52B6M9	15F52B8M9	15F52B12M9	15F52B16M9
3/4	M12	20,000 (1,379)	15F52B4M12	15F52B6M12	15F52B8M12	15F52B12M12	15F52B16M12
1	M16	20,000 (1,379)	15F52B4M16	15F52B6M16	15F52B8M16	15F52B12M16	15F52B16M16
High-Pressure							
1	M16H	43,000 (2,965)	15F52B4M16H	15F52B6M16H	15F52B8M16H	15F52B12M16H	15F52B16M16H
1/4	H4	60,000 (4,137)	15F52B4H4	15F52B6H4	15F52B8H4	15F52B12H4	15F52B16H4
3/8	H6	60,000 (4,137)	15F52B4H6	15F52B6H6	15F52B8H6	15F52B12H6	15F52B16H6
9/16	H9	60,000 (4,137)	15F52B4H9	15F52B6H9	15F52B8H9	15F52B12H9	15F52B16H9
Ultra-High Pressure							
1/4	U4	100,000 (6,896)	15F52B4U4	15F52B6U4	15F52B8U4	15F52B12U4	15F52B16U4
3/8	U6	100,000 (6,896)	15F52B4U6	15F52B6U6	15F52B8U6	15F52B12U6	15F52B16U6
9/16	U9	100,000 (6,896)	15F52B4U9	15F52B6U9	15F52B8U9	15F52B12U9	15F52B16U9
5/16	U5	150,000 (10,344)	15F52B4U5	15F52B6U5	15F52B8U5	15F52B12U5	15F52B16U5

\* The pressure rating of any adapter is the value of the lowest rated connection in the fitting.

- Low Pressure
- Needle Valves
- Check Valves
- Relief Valves
- Filters
- Fittings
- Adapters and Couplings
- Adapters (Male to Female)
- Couplings (Female to Female)
- Adapters (Male to Male)

Pressure to 15,000psi (1,034bar)

# Low Pressure—Adapters (Male to Male)

**HIFLUID**

**Selection Example**

15		F53		P12		M4
Pressure Rating		Component Type		Male Size		Male Size
15	15,000psi	F53	Adapters (Male to Male)	P4	NPT1/4"	P4, B4, M4, H4, U4-1/4"
				P6	NPT3/8"	U5-5/16"
				P8	NPT1/2"	P6, B6, M6, H6, U6-3/8"
				P12	NPT3/4"	P8, B8-1/2"
				P16	NPT1"	M9, H9, U9-9/16"
				B4	BSP1/4"	P12, B12, M12-3/4"
				B6	BSP3/8"	P16, B16-1"
				B8	BSP1/2"	M16-1" (20 series)
				B12	BSP3/4"	M16H-1" (43 series)
				B16	BSP1"	M24-1-1/2"

-  Low Pressure
- Needle Valves
- Check Valves
- Relief Valves
- Filters
- Fittings
- Adapters and Couplings
  - Adapters (Male to Female)
  - Couplings (Female to Female)
  - Adapters (Male to Male)**

# Low Pressure—Adapters (Male to Male)



- Needle Valves
- Check Valves
- Relief Valves
- Filters
- Fittings
- Adapters and Couplings
- Adapters (Male to Female)
- Couplings (Female to Female)
- Adapters (Male to Male)

## Model Data

Male			Male				
O.D. Size in.	Connection Type	Max. Pressure psi (bar)*	15,000psi (1,034bar)				
			1/4" P4	3/8" P6	1/2" P8	3/4" P12	1" P16
Low-Pressure			Low-Pressure				
1/4	P4	15,000 (1,034)	15F53P4	15F53P4P6	15F53P4P8	15F53P4P12	15F53P4P16
3/8	P6	15,000 (1,034)		15F53P6	15F53P6P8	15F53P6P12	15F53P6P16
1/2	P8	15,000 (1,034)			15F53P8	15F53P8P12	15F53P8P16
3/4	P12	15,000 (1,034)				15F53P12	15F53P12P16
1	P16	15,000 (1,034)					15F53P16
1/4	B4	15,000 (1,034)	15F53B4P4	15F53B4P6	15F53B4P8	15F53B4P12	15F53B4P16
3/8	B6	15,000 (1,034)	15F53P4B6	15F53B6P6	15F53B6P8	15F53B6P12	15F53B6P16
1/2	B8	15,000 (1,034)	15F53P4B8	15F53P6B8	15F53P8B8	15F53P8B12	15F53B8P16
3/4	B12	15,000 (1,034)	15F53P4B12	15F53P6B12	15F53P8B12	15F53P12B12	15F53B12P16
1	B16	15,000 (1,034)	15F53P4B16	15F53P6B16	15F53P8B16	15F53P12B16	15F53B16P16
Medium-Pressure							
1-1/2	M24	15,000 (1,034)	15F53P4M24	15F53P6M24	15F53P8M24	15F53P12M24	15F53P16M24
1/4	M4	20,000 (1,379)	15F53P4M4	15F53P6M4	15F53P8M4	15F53P8M24	15F53P16M4
3/8	M6	20,000 (1,379)	15F53P4M6	15F53P6M6	15F53P8M6	15F53P12M6	15F53P16M6
1/2	M9	20,000 (1,379)	15F53P4M9	15F53P6M9	15F53P8M9	15F53P12M9	15F53P16M9
3/4	M12	20,000 (1,379)	15F53P4M12	15F53P6M12	15F53P8M12	15F53P12M12	15F53P16M12
1	M16	20,000 (1,379)	15F53P4M16	15F53P6M16	15F53P8M16	15F53P12M16	15F53P16M16
High-Pressure							
1	M16H	43,000 (2,965)	15F53P4M16H	15F53P6M16H	15F53P8M16H	15F53P12M16H	15F53P16M16H
1/4	H4	60,000 (4,137)	15F53P4H4	15F53P6H4	15F53P8H4	15F53P12H4	15F53P16H4
3/8	H6	60,000 (4,137)	15F53P4H6	15F53P6H6	15F53P8H6	15F53P12H6	15F53P16H6
9/16	H9	60,000 (4,137)	15F53P4H9	15F53P6H9	15F53P8H9	15F53P12H9	15F53P16H9
Ultra-High Pressure							
1/4	U4	100,000 (6,896)	15F53P4U4	15F53P6U4	15F53P8U4	15F53P12U4	15F53P16U4
3/8	U6	100,000 (6,896)	15F53P4U6	15F53P6U6	15F53P8U6	15F53P12U6	15F53P16U6
9/16	U9	100,000 (6,896)	15F53P4U9	15F53P6U9	15F53P8U9	15F53P12U9	15F53P16U9
5/16	U5	150,000 (10,344)	15F53P4U5	15F53P6U5	15F53P8U5	15F53P12U5	15F53P16U5

\* The pressure rating of any adapter is the value of the lowest rated connection in the fitting.

# Low Pressure—Adapters (Male to Male)



Needle Valves  
Check Valves  
Relief Valves  
Filters  
Fittings  
Adapters and Couplings  
Adapters (Male to Female)  
Couplings (Female to Female)  
Adapters (Male to Male)

## Model Data

Male			Male				
O.D. Size in.	Connection Type	Max. Pressure psi (bar)*	15,000psi (1,034bar)				
			1/4" B4	3/8" B6	1/2" B8	3/4" B12	1" B16
Low-Pressure			Low-Pressure				
1/4	B4	15,000 (1,034)	15F53B4	15F53B4B6	15F53B4B8	15F53B4B12	15F53B4B16
3/8	B6	15,000 (1,034)		15F53B6	15F53B6B8	15F53B6B12	15F53B6B16
1/2	B8	15,000 (1,034)			15F53B8	15F53B8B12	15F53B8B16
3/4	B12	15,000 (1,034)				15F53B12	15F53B12B16
1	B16	15,000 (1,034)					15F53B16
Medium-Pressure			Medium-Pressure				
1-1/2	M24	15,000 (1,034)	15F53B4M24	15F53B6M24	15F53B8M24	15F53B12M24	15F53B16M24
1/4	M4	20,000 (1,379)	15F53B4M4	15F53B6M4	15F53B8M4	15F53B12M4	15F53B16M4
3/8	M6	20,000 (1,379)	15F53B4M6	15F53B6M6	15F53B8M6	15F53B12M6	15F53B16M6
9/16	M9	20,000 (1,379)	15F53B4M9	15F53B6M9	15F53B8M9	15F53B12M9	15F53B16M9
3/4	M12	20,000 (1,379)	15F53B4M12	15F53B6M12	15F53B8M12	15F53B12M12	15F53B16M12
1	M16	20,000 (1,379)	15F53B4M16	15F53B6M16	15F53B8M16	15F53B12M16	15F53B16M16
High-Pressure			High-Pressure				
1	M16H	43,000 (2,965)	15F53B4M16H	15F53B6M16H	15F53B8M16H	15F53B12M16H	15F53B16M16H
1/4	H4	60,000 (4,137)	15F53B4H4	15F53B6H4	15F53B8H4	15F53B12H4	15F53B16H4
3/8	H6	60,000 (4,137)	15F53B4H6	15F53B6H6	15F53B8H6	15F53B12H6	15F53B16H6
9/16	H9	60,000 (4,137)	15F53B4H9	15F53B6H9	15F53B8H9	15F53B12H9	15F53B16H9
Ultra-High Pressure			Ultra-High Pressure				
1/4	U4	100,000 (6,896)	15F52B4U4	15F52B6U4	15F52B8U4	15F52B12U4	15F52B16U4
3/8	U6	100,000 (6,896)	15F52B4U6	15F52B6U6	15F52B8U6	15F52B12U6	15F52B16U6
9/16	U9	100,000 (6,896)	15F52B4U9	15F52B6U9	15F52B8U9	15F52B12U9	15F52B16U9
5/16	U5	150,000 (10,344)	15F53B4U5	15F53B6U5	15F53B8U5	15F53B12U5	15F53B16U5

\* The pressure rating of any adapter is the value of the lowest rated connection in the fitting.

- Low Pressure
- Medium Pressure
- High Pressure
- Ultra-High Pressure
- Technical Information

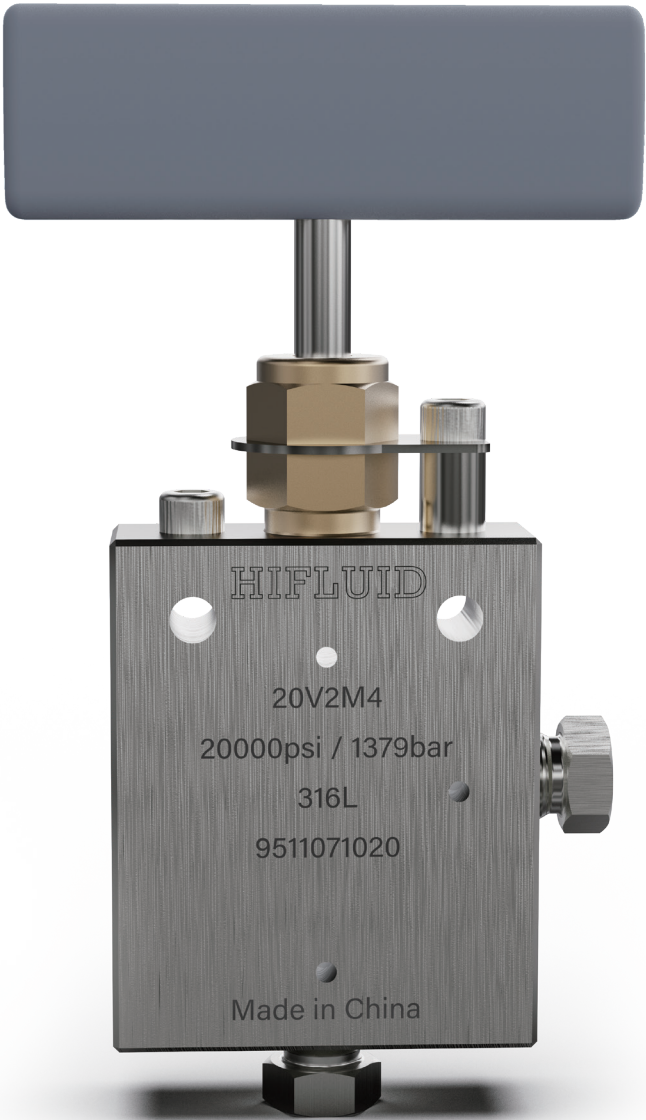

# Medium Pressure

to 20,000psi (1,379bar)

HiFluid's medium-pressure product portfolio comprises needle valves (hand-operated), actuator needle valves, check valves, relief valves, filters, fittings and tubing. All valve and fitting interfaces adopt the cone-and-thread connection, providing excellent sealing performance and stable pressure resistance.



### Needle Valves (Hand-Operated)

A needle valve controls gas or liquid flow by manually adjusting the stem travel. Precision flow-control models are available as required.

HiFluid offers a complete range of needle valves; selected models feature replaceable seats to simplify maintenance and reduce cost. All valves are supplied with glands and collars to ensure reliable connection and sealing.

Each valve body is laser-etched with model, serial number, maximum working pressure, and primary material to ensure full traceability and compliance with standardized quality control.

#### Features

- Non-rotating rising stem design minimizes wear between needle and seat, extending service life.
- 316L duplex wetted parts and 17-4PH stem for outstanding mechanical strength and excellent corrosion resistance.
- Metal-to-metal seating provides long-term stability under high pressure and frequent cycling.
- A safety weep hole is provided between the connection and the sealing surface for leak detection and pressure release.

### Actuator Needle Valves

An actuator needle valve uses an air actuator to open/close the needle for remote automation. The piston-type actuator runs smoothly with fast response, suitable for a variety of industrial automation scenarios.

HiFluid offers both normally-open (NO) and normally-closed (NC) versions to match system logic. Actuators are available in light- and heavy-duty versions to accommodate different driving pressures.

#### Features

- Actuators are made of anodized aluminum, which provides good corrosion resistance.
- Mechanical position indicator provided as standard; optional limit switches are available for remote monitoring or system integration.
- Spring-return design as standard; double-acting construction available according to application requirements.
- Except for the actuator, all performance characteristics are identical to the hand-operated needle valves.



Needle Valves  
Hand-Operated  
Actuator  
Check Valves  
Relief Valves  
Filters  
Fittings  
Adapters and  
Couplings  
Tubing

# Medium Pressure—Needle Valves (Hand-Operated)

## Selection Example

20		V2		M4		-B	
Pressure Rating		Body Pattern		Connection Size		Options	
15 (only M24)	15,000psi	V1	2-Way Straight	M4	1/4"	B	Cryogenic Packing -73°C (-100°F)
20	20,000psi	V2	2-Way Angle	M6	3/8"	GY	Graphite Braided Yarn Packing 426°C (799°F)
		V3	3-Way, 2 on Pressure	M9	9/16"	HT	High Temperature Option 649°C (1200°F)
		V4	3-Way, 1 on Pressure	M12	3/4"	LT	Low Temperature Option -253°C (-423°F)
		V5	3-Way, 2-Stem Manifold	M16	1"	TG	Teflon Glass Packing 315°C (600°F)
				M24	1-1/2" (only 15 series)	H2	Hydrogen Service
						O2	Oxygen Service
						R	Regulating Stem
						RC	Regulating Stem with Replaceable Seat
						C	Vee Stem with Replaceable Seat

- Needle Valves
- Hand-Operated Actuator
- Check Valves
- Relief Valves
- Filters
- Fittings
- Adapters and Couplings
- Tubing

## Flow Coefficient

O.D. Size in.(mm)	Connection Type	Orifice Size in.(mm)	Rated (Cv*)	Pressure Rating @R.T. (psi (bar))**
1/4 (6.35)	M4F	0.106 (2.7)	0.31	20,000 (1,379)
3/8 (9.53)	M6F	0.201 (5.1)	0.75	20,000 (1,379)
9/16 (14.29)	M9F	0.307 (7.8)	1.3	20,000 (1,379)
3/4 (19.05)	M12F	0.438 (11.1)	2.5	20,000 (1,379)
1 (25.4)	M16F	0.562 (14.3)	4.4	20,000 (1,379)
1-1/2 (38.1)	M24F	0.937 (23.8)	14	15,000 (1,034)

## Flow Curve

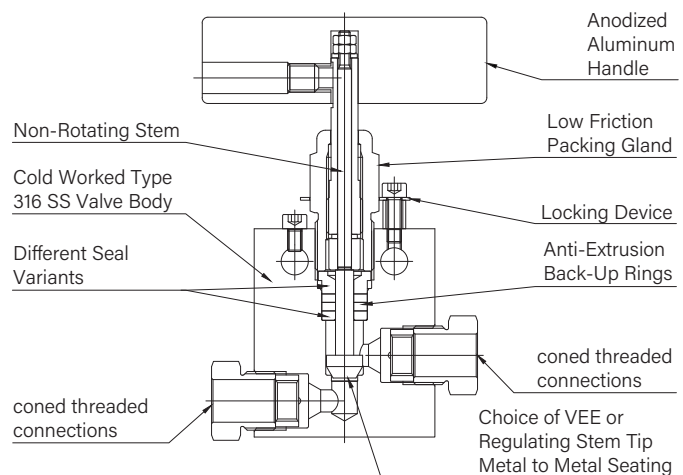
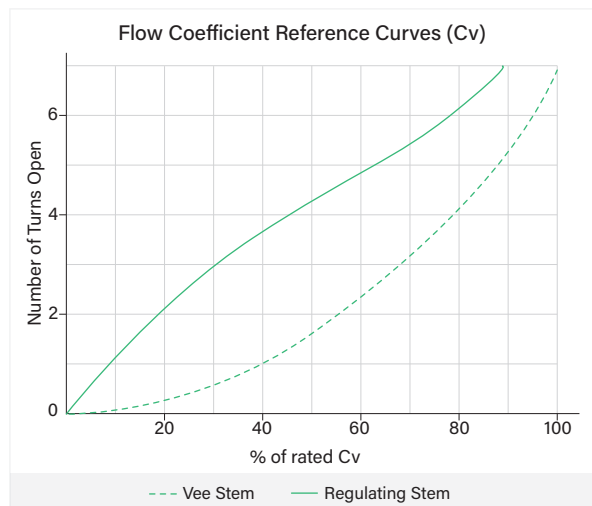

\* Cv values shown are for 2-way straight pattern vee stem valves. For 2-way angle patterns, increase the Cv value by 50%.

\*\* For the pressure-temperature relationship, refer to the guidance in the "Technical Information" section.

# Medium Pressure—Needle Valves (Hand-Operated)

## Dimensions

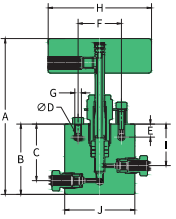
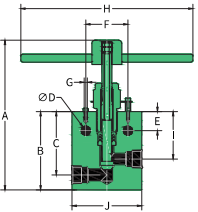
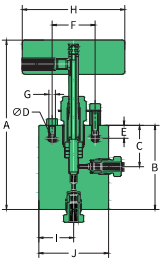
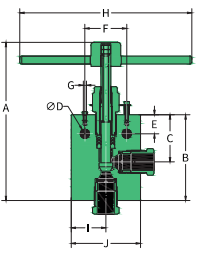
Valve Pattern	Type	O.D. Size in.	Orifice in. (mm)	Dimensions in. (mm)										Valve Panel Hole	Block Thickness
				A	B	C	D	E	F	H	I	J	K		
<b>2-Way Straight</b>															
	20V1M4	1/4	0.106 (2.7)	4.61 (117)	2.01 (51)	1.62 (41.1)	0.22 (5.5)	0.37 (9.5)	1.24 (31.5)	2.95 (75)	1.19 (30.2)	2.01 (51)		0.75 (19.1)	0.79 (20)
	20V1M6	3/8	0.201 (5.1)	4.61 (117)	2.01 (51)	1.62 (41.1)	0.22 (5.5)	0.37 (9.5)	1.24 (31.5)	2.95 (75)	1.19 (30.2)	2.01 (51)		0.75 (19.1)	0.79 (20)
	20V1M9	9/16	0.307 (7.8)	5.87 (149)	2.88 (73.2)	2.38 (60.5)	0.37 (9.5)	0.45 (11.5)	1.38 (35)	3.94 (100)	1.75 (44.5)	2.50 (63.5)		1.00 (25.4)	1.02 (26)
	20V1M12	3/4	0.438 (11.1)	7.05 (179)	3.74 (95)	3.00 (76)	0.43 (11)	0.63 (16)	1.76 (44.7)	10.31 (262)	2.25 (57.2)	3.00 (76)		1.25 (31.8)	1.38 (35)
	20V1M16	1	0.562 (14.3)	8.98 (228)	4.65 (118)	3.75 (95.3)	0.53 (13.5)	1.13 (28.7)	2.50 (63.5)	10.31 (262)	2.81 (71.4)	4.13 (105)		1.62 (41.1)	1.77 (45)
	15V1M24	1-1/2	0.937 (23.8)	10.8 (275)	6.5 (165)	5.25 (135)	0.75 (19)	1.5 (38.1)	3.75 (95.25)	23.23 (590)	3.75 (95.25)	5.71 (145)		2.2 (56)	2.24 (57)
<b>2-Way Angle</b>															
	20V2M4	1/4	0.106 (2.7)	5.00 (127)	2.43 (61.7)	1.19 (30.2)	0.22 (5.6)	0.37 (9.5)	1.24 (31.5)	2.95 (75)	1.00 (25.4)	2.01 (51)		0.75 (19.1)	0.79 (20)
	20V2M6	3/8	0.201 (5.1)	5.00 (127)	2.43 (61.7)	1.19 (30.2)	0.22 (5.6)	0.37 (9.5)	1.24 (31.5)	2.95 (75)	1.00 (25.4)	2.01 (51)		0.75 (19.1)	0.79 (20)
	20V2M9	9/16	0.307 (7.8)	6.36 (161.5)	3.38 (85.9)	1.75 (44.5)	0.37 (9.5)	0.45 (11.5)	1.38 (35)	3.94 (100)	1.25 (31.8)	2.50 (63.5)		1.00 (25.4)	1.02 (26)
	20V2M12	3/4	0.438 (11.1)	7.56 (192)	4.25 (108)	2.25 (57.2)	0.43 (11)	0.63 (16)	1.76 (44.7)	10.31 (262)	1.50 (38)	3.00 (76)		1.25 (31.8)	1.38 (35)
	20V2M16	1	0.562 (14.3)	9.45 (240)	5.12 (130)	2.81 (71.4)	0.53 (13.5)	1.13 (28.7)	2.50 (63.5)	10.31 (262)	2.07 (52.5)	4.13 (105)		1.62 (41.1)	1.77 (45)
	15V2M24	1-1/2	0.937 (23.8)	11 (280)	6.7 (170)	3.75 (95.25)	0.75 (19)	1.5 (38.1)	3.75 (95.25)	23.23 (590)	2.87 (73)	5.71 (145)		2.2 (56)	2.24 (57)

Note: Dimensions are for reference only; contact HiFluid for further requirements.

-  Medium Pressure
- Needle Valves
- Hand-Operated Actuator
- Check Valves
- Relief Valves
- Filters
- Fittings
- Adapters and Couplings
- Tubing

# Medium Pressure—Needle Valves (Hand-Operated)

## Dimensions

Valve Pattern	Type	O.D. Size in.	Orifice in. (mm)	Dimensions in. (mm)										Valve Panel Hole	Block Thickness
				A	B	C	D	E	F	H	I	J	K		
<b>3-Way, 2 on Pressure</b>															
	20V3M4	1/4	0.106 (2.7)	5.20 (132)	2.62 (66.5)	1.62 (41.1)	0.22 (5.6)	0.37 (9.5)	1.24 (31.5)	2.95 (75)	1.00 (25.4)	2.01 (51)	1.19 (30.2)	0.75 (19.1)	0.79 (20)
	20V3M6	3/8	0.201 (5.1)	5.20 (132)	2.62 (66.5)	1.62 (41.1)	0.22 (5.6)	0.37 (9.5)	1.24 (31.5)	2.95 (75)	1.00 (25.4)	2.01 (51)	1.19 (30.2)	0.75 (19.1)	0.79 (20)
	20V3M9	9/16	0.307 (7.8)	6.60 (167.6)	3.62 (92)	2.38 (60.5)	0.37 (9.5)	0.45 (11.5)	1.38 (35)	3.94 (100)	1.25 (31.8)	2.50 (63.5)	1.75 (44.5)	1.00 (25.4)	1.02 (26)
	20V3M12	3/4	0.438 (11.1)	7.91 (201)	4.63 (117.5)	3.00 (76)	0.43 (11)	0.63 (16)	1.76 (44.7)	10.31 (262)	1.50 (38)	3.00 (76)	2.25 (57.2)	1.25 (31.8)	1.38 (35)
	20V3M16	1	0.562 (14.3)	10.20 (259)	5.87 (149)	3.75 (95.3)	0.53 (13.5)	1.13 (28.7)	2.50 (63.5)	10.31 (262)	2.07 (52.5)	4.13 (105)	2.81 (71.4)	1.62 (41.1)	1.77 (45)
<b>3-Way, 1 on Pressure</b>															
	20V4M4	1/4	0.106 (2.7)	5.00 (127)	2.43 (61.7)	1.19 (30.2)	0.22 (5.6)	0.37 (9.5)	1.24 (31.5)	2.95 (75)	1.00 (25.4)	2.01 (51)		0.75 (19.1)	0.79 (20)
	20V4M6	3/8	0.201 (5.1)	5.00 (127)	2.43 (61.7)	1.19 (30.2)	0.22 (5.5)	0.37 (9.5)	1.24 (31.5)	2.95 (75)	1.00 (25.4)	2.01 (51)		0.75 (19.1)	0.79 (20)
	20V4M9	9/16	0.307 (7.8)	6.34 (161)	3.38 (85.9)	1.75 (44.5)	0.37 (9.5)	0.45 (11.5)	1.38 (35)	3.94 (100)	1.25 (31.8)	2.50 (63.5)		1.00 (25.4)	1.02 (26)
	20V4M12	3/4	0.438 (11.1)	7.56 (192)	4.25 (108)	2.25 (57.2)	0.43 (11)	0.63 (16)	1.76 (44.7)	10.31 (262)	1.50 (38)	3.00 (76)		1.25 (31.8)	1.38 (35)
	20V4M16	1	0.562 (14.3)	9.53 (242)	5.20 (132)	2.81 (71.4)	0.53 (13.5)	1.13 (28.7)	2.50 (63.5)	10.31 (262)	2.07 (52.5)	4.13 (105)		1.62 (41.1)	1.77 (45)

Note: Dimensions are for reference only; contact HiFluid for further requirements.

- Medium Pressure
- Needle Valves
- Hand-Operated Actuator
- Check Valves
- Relief Valves
- Filters
- Fittings
- Adapters and Couplings
- Tubing

# Medium Pressure—Needle Valves (Hand-Operated)

## Dimensions

Valve Pattern	Type	O.D. Size in.	Orifice in. (mm)	Dimensions in. (mm)										Valve Panel Hole	Block Thickness
				A	B	C	D	E	F	H	I	J	K		
<b>3-Way, 2-Stem Manifold</b>															
	20V5M4	1/4	0.106 (2.7)	8.54 (217)	3.39 (86)	1.19 (30.2)	0.22 (5.6)	0.37 (9.5)	1.24 (31.5)	2.95 (75)	1.00 (25.4)	2.01 (51)	1.19 (30.2)	0.75 (19.1)	0.79 (20)
	20V5M6	3/8	0.201 (5.1)	8.54 (217)	3.39 (86)	1.19 (30.2)	0.22 (5.6)	0.37 (9.5)	1.24 (31.5)	2.95 (75)	1.00 (25.4)	2.01 (51)	1.19 (30.2)	0.75 (19.1)	0.79 (20)
	20V5M9	9/16	0.307 (7.8)	11.1 (282)	5.12 (130)	2.56 (65)	0.37 (9.5)	0.45 (11.5)	1.38 (35)	3.94 (100)	1.25 (31.8)	2.50 (63.5)	1.75 (44.5)	1.00 (25.4)	1.02 (26)
	20V5M12	3/4	0.438 (11.1)	13.07 (332)	6.50 (165)	3.25 (82.5)	0.43 (11)	0.63 (16)	1.76 (44.7)	10.31 (262)	1.50 (38)	3.00 (76)	2.25 (57.2)	1.25 (31.8)	1.38 (35)
	20V5M16	1	0.562 (14.3)	16.18 (411)	7.52 (191)	3.76 (95.5)	0.53 (13.5)	1.13 (28.7)	2.50 (63.5)	10.31 (262)	2.07 (52.5)	4.13 (105)	2.81 (71.4)	1.62 (41.1)	1.77 (45)
<b>2-Way Angle (Replaceable Seat)</b>															
	20V2M4-C	1/4	0.106 (2.7)	4.84 (123)	2.25 (57.2)	1.19 (30.2)	0.22 (5.6)	0.37 (9.5)	1.24 (31.5)	2.95 (75)	1.00 (25.4)	2.01 (51)		0.75 (19.1)	0.79 (20)
	20V2M6-C	3/8	0.201 (5.1)	4.84 (123)	2.25 (57.2)	1.19 (30.2)	0.22 (5.6)	0.37 (9.5)	1.24 (31.5)	2.95 (75)	1.00 (25.4)	2.01 (51)		0.75 (19.1)	0.79 (20)
	20V2M9-C	9/16	0.307 (7.8)	6.65 (169)	3.21 (81.5)	1.75 (44.5)	0.37 (9.5)	0.45 (11.5)	1.38 (35)	3.94 (100)	1.25 (31.8)	2.50 (63.5)		1.00 (25.4)	1.02 (26)
	20V2M12-C	3/4	0.438 (11.1)	7.56 (192)	4.25 (108)	2.25 (57.2)	0.43 (11)	0.63 (16)	1.76 (44.7)	10.31 (262)	1.50 (38)	3.00 (76)		1.25 (31.8)	1.38 (35)
	20V2M16-C	1	0.562 (14.3)	9.57 (243)	5.25 (133.3)	2.81 (71.4)	0.53 (13.5)	1.13 (28.7)	2.50 (63.5)	10.31 (262)	2.07 (52.5)	4.13 (105)		1.62 (41.1)	1.77 (45)

Note: Dimensions are for reference only; contact HiFluid for further requirements.

- Medium Pressure
- Needle Valves
- Hand-Operated Actuator
- Check Valves
- Relief Valves
- Filters
- Fittings
- Adapters and Couplings
- Tubing

# Medium Pressure—Actuator Needle Valves

## Selection Example

20		V1		M6		-HNC		-GY	
Pressure Rating		Body Pattern		Connection Size		Actuator Type		Options	
20	20,000psi	V1	2-Way Straight	M4	1/4"	MNO	Light-Duty NO	B	Cryogenic Packing -73°C (-100°F)
		V2	2-Way Angle	M6	3/8"	HNO	Heavy-Duty NO	GY	Graphite Braided Yarn Packing 426°C (799°F)
				M9	9/16"	MNC	Light-Duty NC	HT	High Temperature Option 649°C (1200°F)
				M12	3/4"	HNC	Heavy-Duty NC	LT	Low Temperature Option -253°C (-423°F)
				M16	1"	MDA	Light-Duty DA	TG	Teflon Glass Packing 315°C (600°F)
						HDA	Heavy-Duty DA	H2	Hydrogen Service
								O2	Oxygen Service

Note: For working pressure, please see "Technical Data".

-  Medium Pressure
- Needle Valves
- Hand-Operated
- Actuator
- Normally-Open
- Normally-Closed
- Double-Acting
- Check Valves
- Relief Valves
- Filters
- Fittings
- Adapters and Couplings
- Tubing

# Medium Pressure—Actuator Needle Valves—Normally-Open

## Dimensions

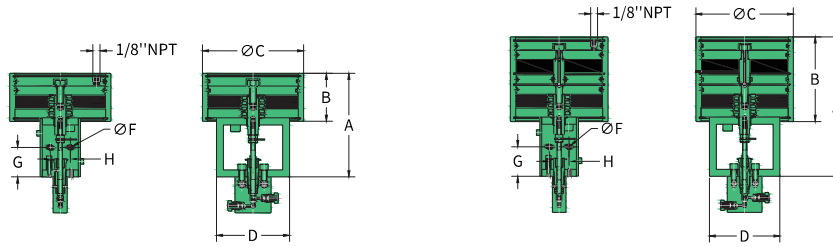

Actuator Type	Suffix	Piston Area in. <sup>2</sup> (mm <sup>2</sup> )	Dimensions in. (mm)						
			A	B	C	D	F	G	H
Light Duty	4;6;9-MNO	19.6 (12.645)	5.79 (147.3)	2.69 (68.3)	5.67 (144)	4.09 (104)	0.28 (7)	1.65 (42)	1.13 (28.8)
Heavy Duty	4;6;9-HNO	39.2 (25.290)	7.78 (197.8)	4.72 (119.9)	5.67 (144)	4.09 (104)	0.28 (7)	1.65 (42)	1.13 (28.8)
Light Duty	12-MNO	19.6 (12.645)	6.58 (167.3)	2.69 (68.3)	5.67 (144)	4.09 (104)	0.28 (7)	2.55 (64.7)	1.13 (28.8)
Heavy Duty	12;16-HNO	39.2 (25.290)	8.58 (217.9)	4.72 (119.9)	5.67 (144)	4.09 (104)	0.28 (7)	2.55 (64.7)	1.13 (28.8)



- Needle Valves
- Hand-Operated Actuator
- Normally-Open
- Normally-Closed
- Double-Acting
- Check Valves
- Relief Valves
- Filters
- Fittings
- Adapters and Couplings
- Tubing

## Technical Data

Pre- pressure Rating	O.D. Size in.	Air Actuator		Air pressure required to close Valve at: System Pressure ksi (bar)										Max. Pressure psi (bar)	Stem Travel in. (mm)	Flow Coefficient Cv*
		Type	Suffix	1-3 (68-207)	4 (275)	6 (414)	8 (551)	10 (689)	12 (827)	14 (965)	16 (1,103)	18 (1,241)	20 (1,379)			
20	1/4	Light Duty	-MNO	40 (2.8)	40 (2.8)	40 (2.8)	40 (2.8)	50 (3.5)	60 (4.2)	70 (4.9)	80 (5.6)	85 (5.9)	95 (6.6)	20,000 (1,379)	0.25 (6.4)	0.31
		Heavy Duty	-HNO	20 (1.4)	20 (1.4)	20 (1.4)	20 (1.4)	25 (1.7)	30 (2.1)	35 (2.4)	40 (2.8)	45 (3.1)	5 (3.5)			
	3/8	Light Duty	-MNO	45 (3.1)	45 (3.1)	45 (3.1)	45 (3.1)	55 (3.8)	65 (4.5)	75 (5.2)	85 (5.9)	95 (6.6)	100 (6.9)	20,000 (1,379)	0.25 (6.4)	0.75
		Heavy Duty	-HNO	25 (1.7)	25 (1.7)	25 (1.7)	25 (1.7)	30 (2.1)	35 (2.4)	40 (2.8)	45 (3.1)	50 (3.5)	55 (3.8)			
	9/16	Light Duty	-MNO	60 (4.2)	60 (4.2)	65 (4.5)	80 (5.6)	100 (6.9)						10,700 (738)	0.38 (9.7)	1.30
		Heavy Duty	-HNO	30 (2.1)	30 (2.1)	30 (2.1)	40 (2.8)	50 (3.5)	55 (3.8)	60 (4.2)	70 (4.9)	80 (5.6)	85 (5.9)	20,000 (1,379)		
	3/4	Light Duty	-MNO	80 (5.6)	80 (5.6)	100 (6.9)								6,100 (421)	0.44 (11.2)	2.50
		Heavy Duty	-HNO	40 (2.8)	40 (2.8)	50 (3.5)	60 (4.2)	75 (5.2)	90 (6.2)	100 (6.9)				13,600 (938)		
	1	Heavy Duty	-HNO	50 (3.5)	50 (3.5)	70 (4.9)	100 (6.9)							8,800 (607)	0.56 (14.2)	3.40

\* Cv values are for straight pattern valves, increase this value by 50% for angle pattern valves.

Pressure to 20,000psi (1,379bar)

# Medium Pressure—Actuator Needle Valves—Normally-Closed

**HIFLUID**

## Dimensions

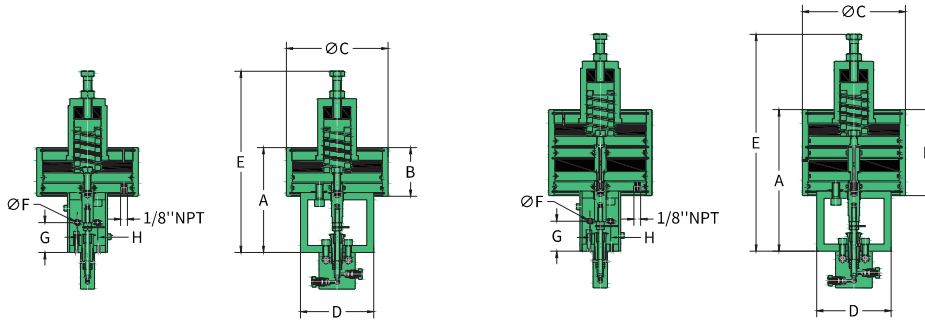

Needle Valves  
Hand-Operated  
Actuator  
Normally-Open  
**Normally-Closed**  
Double-Acting

Check Valves  
Relief Valves  
Filters  
Fittings  
Adapters and  
Couplings  
Tubing

Actuator Type	Suffix	Piston Area in. <sup>2</sup> (mm <sup>2</sup> )	Dimensions in. (mm)							
			A	B	C	D	E*	F	G	H
Light Duty	4;6;9 - MNC	19.6 (12.645)	5.79 (147.3)	2.69 (68.3)	5.67 (144)	4.09 (104)	10.09 (256.3)	0.28 (7)	1.65 (42)	1.13 (28.8)
Heavy Duty	4;6;9 - HNC	39.2 (25.290)	7.78 (197.8)	4.72 (119.9)	5.67 (144)	4.09 (104)	12.59 (320)	0.28 (7)	1.65 (42)	1.13 (28.8)
Heavy Duty	12;16 - HNC	39.2 (25.290)	8.58 (217.9)	4.72 (119.9)	5.67 (144)	4.09 (104)	13.27 (337.8)	0.28 (7)	2.55 (64.7)	1.13 (28.8)

\*E dimension is an approximation only.

# Medium Pressure—Actuator Needle Valves—Normally-Closed HIFLUID

## Technical Data

Pre- ssure Rating	O.D. Size in.	Air Actuator			Air pressure required to open Valve at: System Pressure ksi (bar)								Max. Pressure psi (bar)	Flow Coefficient Cv*	
		Type	Suffix	Data	6 (414)	8 (551)	10 (689)	12 (827)	14 (965)	16 (1,103)	18 (1,241)	20 (1,379)			
20	1/4	Light Duty	-MNC	Air Pressure psi (bar)	65 (4.5)	65 (4.5)	75 (5.2)	85 (5.9)	95 (6.6)	95 (6.6)	95 (6.6)	95 (6.6)	20,000 (1,379)	0.31 - 0.22	
				Spring Pre-Com- pression in. (mm)	0.19 (4.8)	0.19 (4.8)	0.25 (6.4)	0.31 (7.9)	0.38 (9.7)	0.44 (11.2)	0.5 (12.7)	0.56 (14.2)			
				Stem Travel in. (mm)	0.25 (6.4)	0.25 (6.4)	0.25 (6.4)	0.25 (6.4)	0.25 (6.4)	0.19 (4.8)	0.12 (3)	0.06 (1.5)			
		Heavy Duty	-HNC	Air Pressure psi (bar)	35 (2.4)	35 (2.4)	40 (2.8)	45 (3.1)	50 (3.5)	50 (3.5)	50 (3.5)	50 (3.5)			20,000 (1,379)
				Spring Pre-Com- pression in. (mm)	0.19 (4.8)	0.19 (4.8)	0.25 (6.4)	0.31 (7.9)	0.38 (9.7)	0.44 (11.2)	0.5 (12.7)	0.56 (14.2)			
				Stem Travel in. (mm)	0.25 (6.4)	0.25 (6.4)	0.25 (6.4)	0.25 (6.4)	0.25 (6.4)	0.19 (4.8)	0.12 (3)	0.06 (1.5)			
	3/8	Light Duty	-MNC	Air Pressure psi (bar)	65 (4.5)	75 (5.2)	85 (5.9)	95 (6.6)	95 (6.6)	95 (6.6)	95 (6.6)	18,250 (1,258)	0.75 - 0.57		
				Spring Pre-Com- pression in. (mm)	0.19 (4.8)	0.25 (6.4)	0.31 (7.9)	0.38 (9.7)	0.44 (11.2)	0.5 (12.7)	0.56 (14.2)				
				Stem Travel in. (mm)	0.25 (6.4)	0.25 (6.4)	0.25 (6.4)	0.25 (6.4)	0.19 (4.8)	0.12 (3)	0.06 (1.5)				
		Heavy Duty	-HNC	Air Pressure psi (bar)	35 (2.4)	40 (2.8)	45 (3.1)	50 (3.5)	50 (3.5)	50 (3.5)	50 (3.5)			18,250 (1,258)	
				Spring Pre-Com- pression in. (mm)	0.19 (4.8)	0.25 (6.4)	0.31 (7.9)	0.38 (9.7)	0.44 (11.2)	0.5 (12.7)	0.56 (14.2)				
				Stem Travel in. (mm)	0.25 (6.4)	0.25 (6.4)	0.25 (6.4)	0.25 (6.4)	0.19 (4.8)	0.12 (3)	0.06 (1.5)				
9/16	Light Duty	-MNC	Air Pressure psi (bar)	90 (6.2)	95 (6.6)	95 (6.6)					9,800 (676)	1.29 - 0.53			
			Spring Pre-Com- pression in. (mm)	0.34 (8.6)	0.47 (11.9)	0.56 (14.2)									
			Stem Travel in. (mm)	0.25 (6.4)	0.15 (3.8)	0.06 (1.5)									
	Heavy Duty	-HNC	Air Pressure psi (bar)	55 (3.8)	65 (4.5)	70 (4.9)	75 (5.2)	75 (5.2)	75 (5.2)				15,700 (1,082)		
			Spring Pre-Com- pression in. (mm)	0.22 (5.6)	0.28 (7.1)	0.34 (8.6)	0.44 (11.2)	0.5 (12.7)	0.56 (14.2)						
			Stem Travel in. (mm)	0.25 (6.4)	0.25 (6.4)	0.25 (6.4)	0.19 (4.8)	0.12 (3)	0.06 (1.5)						
3/4	Heavy Duty	-HNC	Air Pressure psi (bar)	75 (5.2)	75 (5.2)						9,200 (634)	0.80 - 0.78			
			Spring Pre-Com- pression in. (mm)	0.38 (9.7)	0.56 (14.2)										
			Stem Travel in.(mm)	0.25 (6.4)	0.06 (1.5)										
1	Heavy Duty	-HNC	Air Pressure psi (bar)	75 (5.2)									6,100 (421)	2.73 - 0.15	
			Spring Pre-Com- pression in. (mm)	0.56 (14.2)											
			Stem Travel in. (mm)	0.06 (1.5)											

-  Medium Pressure
- Needle Valves
- Hand-Operated Actuator
- Normally-Open
- Normally-Closed**
- Double-Acting
- Check Valves
- Relief Valves
- Filters
- Fittings
- Adapters and Couplings
- Tubing

\* Cv values are for straight pattern valves, increase this value by 50% for angle pattern valves.  
Cv values vary due to compression of actuator spring, and are adjusted based on system pressure. Values shown are for maximum to minimum stem travel position.

# Medium Pressure—Actuator Needle Valves—Double-Acting

## Dimensions

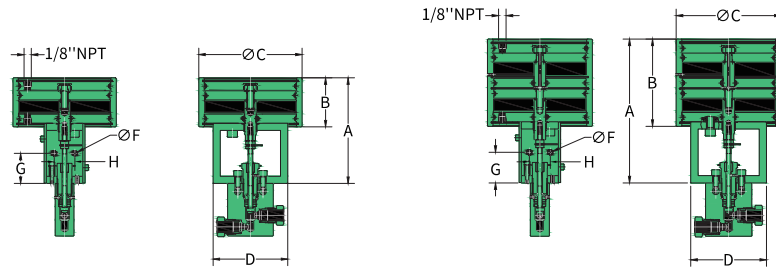

Actuator Type	Suffix	Piston Area in. <sup>2</sup> (mm <sup>2</sup> )	Dimensions in. (mm)						
			A	B	C	D	F	G	H
Light Duty	4;6;9-MDA	19.6 (12.645)	5.79 (147.3)	2.69 (68.3)	5.67 (144)	4.09 (104)	0.28 (7)	1.65 (42)	1.13 (28.8)
Heavy Duty	4;6;9-HDA	39.2 (25.290)	7.78 (197.8)	4.72 (119.9)	5.67 (144)	4.09 (104)	0.28 (7)	1.65 (42)	1.13 (28.8)
Light Duty	12-MDA	19.6 (12.645)	6.58 (167.3)	2.69 (68.3)	5.67 (144)	4.09 (104)	0.28 (7)	2.55 (64.7)	1.13 (28.8)
Heavy Duty	12;16-HDA	39.2 (25.290)	8.58 (217.9)	4.72 (119.9)	5.67 (144)	4.09 (104)	0.28 (7)	2.55 (64.7)	1.13 (28.8)



- Needle Valves
- Hand-Operated Actuator
- Normally-Open
- Normally-Closed
- Double-Acting**
- Check Valves
- Relief Valves
- Filters
- Fittings
- Adapters and Couplings
- Tubing

## Technical Data

Pre- ssure Rating	O.D. Size in.	Air Actuator		Air pressure required to close Valve at: System Pressure ksi (bar)										Max. Pressure psi (bar)	Stem Travel in.(mm)	Flow Coefficient Cv*
		Type	Suffix	1-3 (68-207)	4 (275)	6 (414)	8 (551)	10 (689)	12 (827)	14 (965)	16 (1,103)	18 (1,241)	20 (1,379)			
20	1/4	Light Duty	-MDA	40 (2.8)	40 (2.8)	40 (2.8)	40 (2.8)	50 (3.5)	60 (4.2)	70 (4.9)	80 (5.6)	85 (5.9)	95 (6.6)	20,000 (1,379)	0.25 (6.4)	0.31
		Heavy Duty	-HDA	20 (1.4)	20 (1.4)	20 (1.4)	20 (1.4)	25 (1.7)	30 (2.1)	35 (2.4)	40 (2.8)	45 (3.1)	50 (3.5)			
	3/8	Light Duty	-MDA	45 (3.1)	45 (3.1)	45 (3.1)	45 (3.1)	55 (3.8)	65 (4.5)	75 (5.2)	85 (5.9)	95 (6.6)	100 (6.9)	20,000 (1,379)	0.25 (6.4)	0.75
		Heavy Duty	-HDA	25 (1.7)	25 (1.7)	25 (1.7)	25 (1.7)	30 (2.1)	35 (2.4)	40 (2.8)	45 (3.1)	50 (3.5)	55 (3.8)			
	9/16	Light Duty	-MDA	60 (4.2)	60 (4.2)	65 (4.5)	80 (5.6)	100 (6.9)						10,700 (738)	0.38 (9.7)	1.30
		Heavy Duty	-HDA	30 (2.1)	30 (2.1)	30 (2.1)	40 (2.8)	50 (3.5)	55 (3.8)	60 (4.2)	70 (4.9)	80 (5.6)	85 (5.9)			
	3/4	Light Duty	-MDA	80 (5.6)	80 (5.6)	100 (6.9)								6,100 (421)	0.44 (11.2)	2.50
		Heavy Duty	-HDA	40 (2.8)	40 (2.8)	50 (3.5)	60 (4.2)	75 (5.2)	90 (6.2)	100 (6.9)						
	1	Heavy Duty	-HDA	50 (3.5)	50 (3.5)	70 (4.9)	100 (6.9)							8,800 (607)	0.56 (14.2)	3.40

\* Cv values are for straight pattern valves, increase this value by 50% for angle pattern valves.



## O-Ring Check Valves

An O-ring check valve uses an elastomer O-ring to achieve one-way flow control. The pre-compressed elastic seal prevents reverse flow, delivering tight shutoff and sensitive opening—particularly suitable for medium-pressure gas and liquid control systems.

The standard O-ring check valves seal with FKM, operate from -20°C to 200°C (-4°F to 392°F), The opening pressure of the O-ring check valves is approx. 20psi (1.38bar),  $\pm 30\%$ .

## Ball Check Valves

A ball check valve controls one-way flow using a spherical element. When differential pressure drops below the set opening pressure, the valve automatically closes to prevent backflow—ideal where sealing requirements are relatively lower, but backflow must be avoided.

HiFluid ball check valves are suitable for service up to 349°C (660°F), The opening pressure of the ball check valves is approx. 20psi (1.38bar),  $\pm 30\%$ .



Needle Valves

**Check Valves**

O-Ring Check

Ball Check

Relief Valves

Filters

Fittings

Adapters and

Couplings

Tubing

# Medium Pressure—O-Ring Check Valves

## Selection Example

20		V61		M9		-TO	
Pressure Rating		Component Type		Connection Size		Options	
15 (only M24)	15,000psi	V61	O-Ring Check Valves	M4	1/4"	BO	Buna-N O-ring -29°C to 121°C (-20°F to 250°F)
20	20,000psi			M6	3/8"	EO	EPDM O-ring -40°C to 130°C (-40°F to 266°F)
				M9	9/16"	KO	FFKM O-ring -18°C to 260°C (0°F to 500°F)
				M12	3/4"	LTTO	PTFE O-ring with Low Temp. Spring -252°C (-423°F)
				M16	1"	TO	PTFE O-ring -73°C to 204°C (-100°F to 400°F)
				M24	1-1/2" (only 15 series)		

-  Medium Pressure
- Needle Valves
- Check Valves
  - O-Ring Check
  - Ball Check
- Relief Valves
- Filters
- Fittings
- Adapters and Couplings
- Tubing

## Dimensions

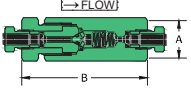
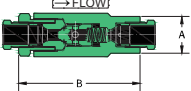
Valve Pattern	Type	Connection Type	Max. Pressure psi (bar)	Orifice in. (mm)	Rated (Cv)	Dimensions in. (mm)	
						A (HEX.)	B
O-Ring Check Valves							
	20V61M4	M4F	20,000 (1,379)	0.106 (2.7)	0.28	0.86 (22)	2.91 (73.9)
	20V61M6	M6F	20,000 (1,379)	0.201 (5.1)	0.84	1.06 (27)	3.31 (84.1)
	20V61M9	M9F	20,000 (1,379)	0.307 (7.8)	2.30	1.42 (36)	4.29 (109)
	20V61M12	M12F	20,000 (1,379)	0.438 (11.1)	4.70	2.00 (50.8)	5.46 (138.7)
	20V61M16	M16F	20,000 (1,379)	0.562 (14.3)	7.40	2.00 (50.8)	6.57 (166.9)
	15V61M24	M24F	15,000 (1,034)	0.937 (23.8)	14	2.24 (57)	9.0 (228.5)

# Medium Pressure—Ball Check Valves

## Selection Example

20		V62		M9		-LTS	
Pressure Rating		Component Type		Connection Size		Options	
15 (only M24)	15,000psi	V62	Ball Check Valve	M4	1/4"	LTS	Low Temperature Spring -252°C (-423°F)
20	20,000psi			M6	3/8"		
				M9	9/16"		
				M12	3/4"		
				M16	1"		
				M24	1-1/2" (only 15 series)		

-  Medium Pressure
- Needle Valves
- Check Valves
  - O-Ring Check
  - Ball Check**
- Relief Valves
- Filters
- Fittings
- Adapters and Couplings
- Tubing

## Dimensions

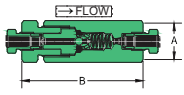
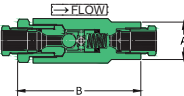
Valve Pattern	Type	Connection Type	Max. Pressure psi (bar)	Orifice in.(mm)	Rated (Cv)	Dimensions in. (mm)	
						A (HEX.)	B
<b>Ball Check Valves</b>							
	20V62M4	M4F	20,000 (1,379)	0.106 (2.7)	0.28	0.86 (22)	2.91 (73.9)
	20V62M6	M6F	20,000 (1,379)	0.201 (5.1)	0.84	1.06 (27)	3.31 (84.1)
	20V62M9	M9F	20,000 (1,379)	0.307 (7.8)	2.30	1.44 (36.5)	4.29 (109)
	20V62M12	M12F	20,000 (1,379)	0.438 (11.1)	4.70	2.00 (50.8)	5.46 (138.7)
	20V62M16	M16F	20,000 (1,379)	0.562 (14.3)	7.40	2.00 (50.8)	6.57 (166.9)
	15V62M24	M24F	15,000 (1,034)	0.937 (23.8)	14	2.24 (57)	9.0 (228.5)



## Relief Valves

A relief valve is an adjustable pressure-safety device used in hydraulic or pneumatic systems to prevent overpressure and ensure safe, stable operation. When system pressure reaches the setpoint, the valve opens to discharge excess pressure, avoiding equipment damage and safety incidents.

HiFluid relief valves provide a 3/4" NPT outlet and modular construction; the seat, collar, and gland are individually replaceable for convenient maintenance and extended service life.

Standard design is hard-seat. A soft-seat option is available for improved sealing performance according to application needs.



- Needle Valves
- Check Valves
- Relief Valves**
- Filters
- Fittings
- Adapters and Couplings
- Tubing

### Selection Example

20		V7		M9		-S	
Pressure Rating		Component Type		Connection Size		Options	
5	5,000psi	V7	Relief Valve	M9	9/16"	S	Soft Seat
10	10,000psi						
15	15,000psi						
20	20,000psi						

### Dimensions

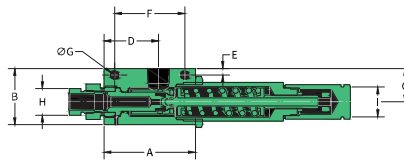

Type	Max. Pressure psi (bar)	Pressure Range min/max psi(bar)	Orifice in. (mm)	Inlet Connection Size	Outlet Connection Size	Dimensions in. (mm)									Block Thick- ness
						A	B	C	D	E	F	G	H (HEX.)	I (HEX.)	
5V7M9	5,000 (345)	3,000/5,000 (207/345)	0.312 (7.92)	M9F	NPT3/4"	3.25 (82.5)	2 (50.8)	1.19 (30.2)	1.94 (49.3)	0.25 (6.35)	2.5 (63.5)	0.30 (7.5)	0.95 (24)	1.06 (27)	1.5 (38)
10V7M9	10,000 (689)	5,000/10,000 (345/689)	0.250 (6.35)	M9F	NPT3/4"	3.25 (82.5)	2 (50.8)	1.19 (30.2)	1.94 (49.3)	0.25 (6.35)	2.5 (63.5)	0.30 (7.5)	0.95 (24)	1.06 (27)	1.5 (38)
15V7M9	15,000 (1,034)	10,000/15,000 (689/1,034)	0.188 (4.78)	M9F	NPT3/4"	3.25 (82.5)	2 (50.8)	1.19 (30.2)	1.94 (49.3)	0.25 (6.35)	2.5 (63.5)	0.30 (7.5)	0.95 (24)	1.06 (27)	1.5 (38)
20V7M9	20,000 (1,379)	15,000/20,000 (1,034/1,379)	0.156 (3.96)	M9F	NPT3/4"	3.25 (82.5)	2 (50.8)	1.19 (30.2)	1.94 (49.3)	0.25 (6.35)	2.5 (63.5)	0.30 (7.5)	0.95 (24)	1.06 (27)	1.5 (38)



### Dual-Disc Line Filters

Dual-Disc Line Filters capture solid contaminants in the fluid to protect downstream equipment and ensure safe operation. The filter adopts a dual-stage, dual-element design. Standard grades include 5/8 μm, 8/30 μm, and 30/56 μm for flexible selection across operating conditions.

Operating temperature range: -253°C to 349°C (-423°F to 660°F), suitable for filtration under both extreme cryogenic and high-temperature conditions. All filters are supplied with glands and collars for reliable connections and convenient maintenance.

### Cup-Type Line Filters

Cup-Type Line Filters capture solid impurities to protect downstream systems. The cup element provides a larger filtration area. Standard ratings: 5μm, 30μm, 56μm.

Operating temperature range: -253°C to 349°C (-423°F to 660°F), suitable for filtration under both extreme cryogenic and high-temperature conditions. All filters are supplied with glands and collars for reliable connections and convenient maintenance.



### Angel Filters



Angle Filters capture solid impurities to protect downstream equipment. Compared with Cup-Type Line Filters, the angle design allows element replacement without dismantling piping, making maintenance more convenient. Standard ratings: 5μm, 30μm, 56μm, which can be flexibly selected according to different operating requirements.

Operating temperature range: -253°C to 349°C (-423°F to 660°F), suitable for filtration under both extreme cryogenic and high-temperature conditions. All angle filters are supplied with glands and collars to ensure reliable connections and ease of maintenance.



Needle Valves

Check Valves

Relief Valves

**Filters**

Dual-Disc Line

Cup-Type Line

Angle

Fittings

Adapters and

Couplings

Tubing

# Medium Pressure—Dual-Disc Line Filters

## Selection Example

20		F61		M9		-5/8	
Pressure Rating		Component Type		Connection Size		Micron Size (µm)	
20	20,000psi	F61	Dual-Disc Line Filters	M9	9/16"	5/8	
						8/30	
						30/56	



- Needle Valves
- Check Valves
- Relief Valves

## Dimensions

Filter Pattern	Type	Max. Pressure psi (bar)	Orifice in. (mm)	Micron Size (µm)	Connec- tion Type	Filter Element Area in <sup>2</sup> (mm <sup>2</sup> )	Dimensions in. (mm)		
							A	B	C (HEX.)
<b>Dual-Disc Line Filters</b>									
	20F61M9-5/8	20,000 (1,379)	0.265 (6.5)	5/8	M9F	0.25 (160)	2.68 (68.1)	4.96 (126)	1.42 (36)
	20F61M9-8/30			8/30					
	20F61M9-30/56			30/56					

- Filters**
- Dual-Disc Line
- Cup-Type Line
- Angle
- Fittings
- Adapters and Couplings
- Tubing

- Note: 1. All fluids entering the high-pressure system should be thoroughly cleaned.  
 2. Filters are designed to remove small process particles.  
 3. The differential pressure across the filter element should not exceed 1,000 psi.

# Medium Pressure—Cup-Type Line Filters

## Selection Example

20		F62		M4		-5
Pressure Rating		Component Type		Connection Size		Micron Size (µm)
20	20,000psi	F62	Cup-Type Line Filters	M4	1/4"	5
				M6	3/8"	30
				M9	9/16"	56
				M12	3/4"	
				M16	1"	

-  Medium Pressure
- Needle Valves
- Check Valves
- Relief Valves
- Filters
  - Dual-Disc Line
  - Cup-Type Line
  - Angle
- Fittings
- Adapters and Couplings
- Tubing

## Dimensions

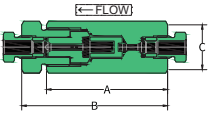
Filter Pattern	Type	Max. Pressure psi (bar)	Orifice in. (mm)	Micron Size (µm)	Connec- tion Type	Filter Element Area in <sup>2</sup> (mm <sup>2</sup> )	Dimensions in. (mm)		
							A	B	C (HEX.)
<b>Cup-Type Line Filters</b>									
	20F62M4-5	20,000 (1,379)	0.106 (2.7)	5	M4F	0.82 (530)	2.38 (60.5)	2.87 (72.9)	0.86 (22)
	20F62M4-30			30					
	20F62M4-56			56					
	20F62M6-5	20,000 (1,379)	0.201(5.1)	5	M6F	0.82 (530)	2.83 (71.8)	3.35 (85.1)	1.06 (27)
	20F62M6-30			30					
	20F62M6-56			56					
	20F62M9-5	20,000 (1,379)	0.307 (7.8)	5	M9F	1.55 (1,000)	3.63 (92.2)	4.33 (110)	1.42 (36)
	20F62M9-30			30					
	20F62M9-56			56					
	20F62M12-5	20,000 (1,379)	0.438 (11.1)	5	M12F	6.14 (3,960)	5.75 (146)	6.57 (166.9)	2.00 (50.8)
	20F62M12-30			30					
	20F62M12-56			56					
	20F62M16-5	20,000 (1,379)	0.562 (14.3)	5	M16F	6.14 (3,960)	5.75 (146)	6.57 (166.9)	2.00 (50.8)
	20F62M16-30			30					
	20F62M16-56			56					

- Note: 1. All fluids entering the high-pressure system should be thoroughly cleaned.  
 2. Filters are designed to remove small process particles.  
 3. The differential pressure across the filter element should not exceed 1,000 psi.

# Medium Pressure—Angle Filters

## Selection Example

20		F63		M6		-5	
Pressure Rating		Component Type		Connection Size		Micron Size (µm)	
20	20,000psi	F63	Angle Filter	M4	1/4"	5	
				M6	3/8"	30	
				M9	9/16"	56	
				M12	3/4"		
				M16	1"		

-  Medium Pressure
- Needle Valves
- Check Valves
- Relief Valves
- Filters**
- Dual-Disc Line
- Cup-Type Line
- Angle**
- Fittings
- Adapters and Couplings
- Tubing

## Dimensions

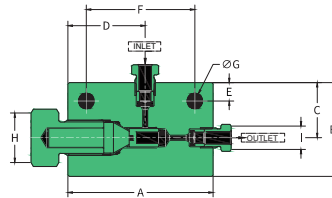

Type	Max. Pressure psi (bar)	Orifice in. (mm)	Connection Type	Micron Size (µm)	Filter Element Area in <sup>2</sup> (mm <sup>2</sup> )	Dimensions in. (mm)										Block Thick- ness
						A	B	C	D	E	F	G	H (HEX.)	I (HEX.)		
<b>Angle Filters</b>																
20F63M4-5	20,000 (1,379)	0.106 (2.7)	M4F	5	0.82 (530)	3.11 (79)	2.01 (51)	1.18 (30)	1.65 (42)	0.39 (10)	2.32 (59)	0.34 (8.5)	1.06 (27)	0.51 (13)	1.02 (26)	
20F63M4-30				30												
20F63M4-56				56												
20F63M6-5	20,000 (1,379)	0.201 (5.1)	M6F	5	0.82 (530)	3.11 (79)	2.01 (51)	1.18 (30)	1.65 (42)	0.39 (10)	2.32 (59)	0.34 (8.5)	1.06 (27)	0.51 (13)	1.02 (26)	
20F63M6-30				30												
20F63M6-56				56												
20F63M9-5	20,000 (1,379)	0.307 (7.8)	M9F	5	1.55 (1,000)	3.62 (92)	2.64 (67)	1.61 (41)	1.81 (46)	0.51 (13)	2.17 (55)	0.34 (8.5)	1.18 (30)	0.94 (24)	1.54 (39)	
20F63M9-30				30												
20F63M9-56				56												
20F63M12-5	20,000 (1,379)	0.438 (11.1)	M12F	5	6.14 (3,960)	5.71 (145)	3.54 (90)	2.3 (58.4)	2.44 (62)	0.39 (10)	4.92 (125)	0.34 (8.5)	2.00 (50.8)	1.18 (30)	2.24 (57)	
20F63M12-30				30												
20F63M12-56				56												
20F63M16-5	20,000 (1,379)	0.562 (14.3)	M16F	5	6.14 (3,960)	5.71 (145)	3.54 (90)	2.3 (58.4)	2.44 (62)	0.39 (10)	4.92 (125)	0.34 (8.5)	2.00 (50.8)	1.42 (36)	2.24 (57)	
20F63M16-30				30												
20F63M16-56				56												

- Note: 1. All fluids entering the high-pressure system should be thoroughly cleaned.  
 2. Filters are designed to remove small process particles.  
 3. The differential pressure across the filter element should not exceed 1,000 psi.



### Accessories

All medium pressure fittings are supplied with glands and collars to ensure sealing integrity and connection stability during field installation. Users may also purchase glands and collars separately as needed for more flexible system configuration.

### Straight Coupling, Elbow, Tee, Cross

HiFluid supplies a full range of straight coupling, elbow, tee, and cross fittings for multi-directional connections in medium-pressure systems. All interfaces adopt the medium-pressure cone-and-thread design to ensure reliable sealing and stable connections under medium-pressure conditions.



### Anti-Vibration Collet Gland Assemblies

HiFluid anti-vibration collet gland assemblies are designed for piping systems subject to severe vibration or impact loads. They effectively buffer dynamic disturbances at the connection points, improving system stability and operational reliability.



Needle Valves

Check Valves

Relief Valves

Filters

**Fittings**

Accessories

Straight Coupling

Elbow, Tee, Cross

Anti-Vibration

Collet Gland

Assembly

Adapters and

Couplings

Tubing





# Medium Pressure—Accessories

## Selection Example

20		F71		M6	
Pressure Rating		Component Type		Connection Size	
15 (only M24)	15,000psi	F71	Gland	M4	1/4"
20	20,000psi	F72	Collar	M6	3/8"
		F73	Plug	M9	9/16"
		F74	Tubing Cap	M12	3/4"
				M16	1"
				M24	1-1/2" (only 15 series)

-  Medium Pressure
- Needle Valves
- Check Valves
- Relief Valves
- Filters
- Fittings**
- Accessories**
- Straight Coupling
- Elbow, Tee, Cross
- Anti-Vibration
- Collet Gland
- Assemblies

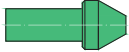
## Dimensions

O.D.Size in. (mm)	Gland	Collar	Plug	Tubing Cap
				
1-1/2 (38.1)	15F71M24	15F72M24	15F73M24	15F74M24
1/4 (6.35)	20F71M4	20F72M4	20F73M4	20F74M4
3/8 (9.53)	20F71M6	20F72M6	20F73M6	20F74M6
9/16 (14.29)	20F71M9	20F72M9	20F73M9	20F74M9
3/4 (19.05)	20F71M12	20F72M12	20F73M12	20F74M12
1 (25.4)	20F71M16	20F72M16	20F73M16	20F74M16

- Adapters and Couplings
- Tubing

Pressure to 20,000psi (1,379bar)

# Medium Pressure—Straight Coupling, Elbow, Tee, Cross

**HIFLUID**

## Selection Example

20		F2		M12	
Pressure Rating		Body Pattern		Connection Size	
15 (only M24)	15,000psi	F1	Straight Coupling	M4	1/4"
20	20,000psi	F2	Elbow	M6	3/8"
		F3	Tee	M9	9/16"
		F4	Cross	M12	3/4"
				M16	1"
				M24	1-1/2" (only 15 series)

-  Medium Pressure
- Needle Valves
- Check Valves
- Relief Valves
- Filters
- Fittings**
- Accessories
- Straight Coupling**
- Elbow, Tee, Cross**
- Anti-Vibration
- Collet Gland
- Assemblies
- Adapters and Couplings
- Tubing

## Dimensions

Body Pattern	Type	Connection Type	O.D. Size in.	Orifice in. (mm)	Dimensions in. (mm)							Block Thickness
					A	B	C	D	E	F	G	
<b>Straight Coupling</b>												
	15F1M24	M24F	1-1/2	0.937 (23.8)	5.0 (127)	2.24 (57)						
	20F1M4	M4F	1/4	0.106 (2.7)	1.62 (41.1)	0.71 (18)						
	20F1M6	M6F	3/8	0.201 (5.1)	1.75 (44.5)	0.86 (22)						
	20F1M9	M9F	9/16	0.307 (7.8)	2.12 (53.8)	1.06 (27)						
	20F1M12	M12F	3/4	0.438 (11.1)	2.50 (63.5)	1.42 (36)						
	20F1M16	M16F	1	0.562 (14.3)	3.50 (88.9)	1.13 (28.7)						
<b>Elbow</b>												
	15F2M24	M24F	1-1/2	0.937 (23.8)	2.88 (73.05)	4.00 (101.6)	5.7 (145)	2.88 (73.05)	1.88 (47.83)	3.75 (95.25)	0.56 (14.2)	2.24 (57)
	20F2M4	M4F	1/4	0.106 (2.7)	0.75 (19.1)	1.10 (28)	1.54 (39)	0.75 (19.1)	0.49 (12.5)	0.49 (12.5)	0.22 (5.6)	0.63 (16)
	20F2M6	M6F	3/8	0.201 (5.1)	1.00 (25.4)	1.38 (35)	2.00 (51)	1.00 (25.4)	0.63 (16)	0.63 (16)	0.26 (6.6)	0.79 (20)
	20F2M9	M9F	9/16	0.307 (7.8)	1.25 (31.8)	1.75 (44.5)	2.50 (63.5)	1.25 (31.8)	0.84 (21.3)	0.84 (21.3)	0.33 (8.4)	1.02 (26)
	20F2M12	M12F	3/4	0.438 (11.1)	1.50 (38.1)	2.25 (57.2)	3.00 (76)	1.50 (38.1)	1.00 (25.4)	1.00 (25.4)	0.35 (8.9)	1.38 (35)
	20F2M16	M16F	1	0.562 (14.3)	2.06 (52.3)	3.00 (76)	4.13 (105)	2.06 (52.3)	1.38 (35)	1.38 (35)	0.53 (13.5)	1.77 (45)
<b>Tee</b>												
	15F3M24	M24F	1-1/2	0.937 (23.8)	2.88 (73.05)	4.00 (101.6)	5.7 (145)	2.88 (73.05)	1.88 (47.83)	3.75 (95.25)	0.56 (14.2)	2.24 (57)
	20F3M4	M4F	1/4	0.106 (2.7)	0.75 (19.1)	1.10 (28)	1.54 (39)	0.75 (19.1)	0.49 (12.5)	0.49 (12.5)	0.22 (5.6)	0.63 (16)
	20F3M6	M6F	3/8	0.201 (5.1)	1.00 (25.4)	1.38 (35)	2.00 (51)	1.00 (25.4)	0.63 (16)	0.63 (16)	0.26 (6.6)	0.79 (20)
	20F3M9	M9F	9/16	0.307 (7.8)	1.25 (31.8)	1.75 (44.5)	2.50 (63.5)	1.25 (31.8)	0.84 (21.3)	0.84 (21.3)	0.33 (8.4)	1.02 (26)
	20F3M12	M12F	3/4	0.438 (11.1)	1.50 (38.1)	2.25 (57.2)	3.00 (76)	1.50 (38.1)	1.00 (25.4)	1.00 (25.4)	0.35 (8.9)	1.38 (35)
	20F3M16	M16F	1	0.562 (14.3)	2.06 (52.3)	3.00 (76)	4.13 (105)	2.06 (52.3)	1.38 (35)	1.38 (35)	0.53 (13.5)	1.77 (45)
<b>Cross</b>												
	15F4M24	M24F	1-1/2	0.937 (23.8)	2.88 (73.05)	4.00 (101.6)	5.7 (145)	2.88 (73.05)	1.88 (47.83)	3.75 (95.25)	0.56 (14.2)	2.24 (57)
	20F4M4	M4F	1/4	0.106 (2.7)	0.75 (19.1)	1.10 (28)	1.54 (39)	0.75 (19.1)	0.49 (12.5)	0.49 (12.5)	0.22 (5.6)	0.63 (16)
	20F4M6	M6F	3/8	0.201 (5.1)	1.00 (25.4)	1.38 (35)	2.00 (51)	1.00 (25.4)	0.63 (16)	0.63 (16)	0.26 (6.6)	0.79 (20)
	20F4M9	M9F	9/16	0.307 (7.8)	1.25 (31.8)	2.50 (63.5)	2.50 (63.5)	1.25 (31.8)	0.84 (21.3)	0.84 (21.3)	0.33 (8.4)	1.02 (26)
	20F4M12	M12F	3/4	0.438 (11.1)	1.50 (38.1)	2.25 (57.2)	3.00 (76)	1.50 (38.1)	1.00 (25.4)	1.00 (25.4)	0.35 (8.9)	1.38 (35)
	20F4M16	M16F	1	0.562 (14.3)	2.06 (52.3)	3.00 (76)	4.13 (105)	2.06 (52.3)	1.38 (35)	1.38 (35)	0.53 (13.5)	1.77 (45)

- Medium Pressure
- Needle Valves
- Check Valves
- Relief Valves
- Filters
- Fittings
- Accessories
- Straight Coupling**
- Elbow, Tee, Cross**
- Anti-Vibration
- Collet Gland Assemblies
- Adapters and Couplings
- Tubing

Pressure to 20,000psi (1,379bar)

# Medium Pressure—Anti-Vibration Collet Gland Assemblies

**HIFLUID**

## Selection Example

20		F75		M12		-AVA
Pressure Rating		Component Type		Connection Size		Code
15 (only M24)	15,000psi	F71	Gland	M4	1/4"	AVA-Anti-Vibration Collet Gland Assemblies
20	20,000psi	F72	Collar	M6	3/8"	
		F75	Ferrule	M9	9/16"	
		F8	Vibration-Resistant Coupling	M12	3/4"	
				M16	1"	
				M24	1-1/2" (only 15 serie)	

-  Medium Pressure
- Needle Valves
- Check Valves
- Relief Valves
- Filters
- Fittings
  - Accessories
  - Straight Coupling
  - Elbow, Tee, Cross
  - Anti-Vibration Collet Gland Assemblies

## Dimensions

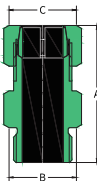
Gland Pattern	Type	Component	O.D. Size in.	Dimensions in. (mm)		
				A	B (HEX.)	C (HEX.)
Anti-Vibration Collet Gland Assemblies						
	15F8M24	Complete Assembly	1-1/2	1.25 (31.75)	2.24 (57)	1.89 (48)
	15F72M24-AVA	Collet Body				
	15F75M24-AVA	Slotted Collet				
	15F71M24-AVA	Gland Nut				
	20F8M4	Complete Assembly	1/4	1.27 (32.2)	0.51 (13)	0.63 (16)
	20F72M4-AVA	Collet Body				
	20F75M4-AVA	Slotted Collet				
	20F71M4-AVA	Gland Nut				
	20F8M6	Complete Assembly	3/8	1.54 (39.1)	0.63 (16)	0.83 (21)
	20F72M6-AVA	Collet Body				
	20F75M6-AVA	Slotted Collet				
	20F71M6-AVA	Gland Nut				
	20F8M9	Complete Assembly	9/16	1.82 (46.2)	0.94 (24)	0.94 (24)
	20F72M9-AVA	Collet Body				
	20F75M9-AVA	Slotted Collet				
	20F71M9-AVA	Gland Nut				
	20F8M12	Complete Assembly	3/4	2.01 (51)	1.18 (30)	1.18 (30)
	20F72M12-AVA	Collet Body				
	20F75M12-AVA	Slotted Collet				
	20F71M12-AVA	Gland Nut				
20F8M16	Complete Assembly	1	2.44 (62)	1.42 (36)	1.42 (36)	
20F72M16-AVA	Collet Body					
20F75M16-AVA	Slotted Collet					
20F71M16-AVA	Gland Nut					

- Adapters and Couplings
- Tubing



## Adapters (Male to Female)

HiFluid male to female adapters convert between different thread types or sizes, connecting a female thread to a male thread. Both ends may use different thread forms and sizes to meet installation needs under complex conditions.

The adapter's pressure rating is limited by the lower rating of the two ends. Naming rule: list the female size first, then the male size.

## Couplings (Female to Female)

HiFluid female to female couplings convert between different thread types or sizes, connecting two male threads. Both ends may use different thread forms and sizes to meet installation needs under complex conditions.

The pressure rating is limited by the lower rating of the two ends. Naming rule: under the same pressure rating, list the smaller size first; if ratings differ, list the lower-pressure first.



## Adapters (Male to Male)

HiFluid male to male adapters convert between different thread types or sizes, connecting two female threads. Both ends may use different thread forms and sizes to meet installation needs under complex conditions.

The pressure rating is limited by the lower rating of the two ends. Naming rule: under the same pressure rating, list the smaller size first; if ratings differ, list the lower-pressure first.



Needle Valves

Check Valves

Relief Valves

Filters

Fittings

**Adapters and Couplings**

Adapters (Male to Female)

Couplings (Female to Female)

Adapters (Male to Male)

Tubing

# Medium Pressure—Adapters (Male to Female)

## Selection Example

20		F51		M12		M4	
Pressure Rating		Component Type		Female Size		Male Size	
15 (only M24)	15,000psi	F51	Adapters (Male to Female)	M4	1/4"	M4, H4, U4-1/4"	
20	20,000psi			M6	3/8"	U5-5/16"	
				M9	9/16"	M6, H6, U6-3/8"	
				M12	3/4"	M9, H9, U9-9/16"	
				M16	1"	M12-3/4"	
				M24	1-1/2" (only 15 series)	M16-1" (20 series)	
						M16H-1" (43 series)	
						M24-1-1/2" (15 series)	

-  Medium Pressure
- Needle Valves
- Check Valves
- Relief Valves
- Filters
- Fittings
- Adapters and Couplings
  - Adapters (Male to Female)
  - Couplings (Female to Female)
  - Adapters (Male to Male)
- Tubing

## Model Data

Male			Female					
O.D. Size in.	Connection Type	Max. Pressure psi (bar)*	15,000psi (1,034bar)	20,000psi (1,379bar)				
			1-1/2" M24	1/4" M4	3/8" M6	9/16" M9	3/4" M12	1" M16
Medium-Pressure			Medium-Pressure					
1-1/2	M24	15,000 (1,034)	15F51M24	15F51M4M24	15F51M6M24	15F51M9M24	15F51M12M24	15F51M16M24
1/4	M4	20,000 (1,379)	15F51M24M4	20F51M4	20F51M6M4	20F51M9M4	20F51M12M4	20F51M16M4
3/8	M6	20,000 (1,379)	15F51M24M6	20F51M4M6	20F51M6	20F51M9M6	20F51M12M6	20F51M16M6
9/16	M9	20,000 (1,379)	15F51M24M9	20F51M4M9	20F51M6M9	20F51M9	20F51M12M9	20F51M16M9
3/4	M12	20,000 (1,379)	15F51M24M12	20F51M4M12	20F51M6M12	20F51M9M12	20F51M12	20F51M16M12
1	M16	20,000 (1,379)	15F51M24M16	20F51M4M16	20F51M6M16	20F51M9M16	20F51M12M16	20F51M16
High-Pressure			High-Pressure					
1	M16H	43,000 (2,965)	15F51M24M16H	20F51M4M16H	20F51M6M16H	20F51M9M16H	20F51M12M16H	20F51M16M16H
1/4	H4	60,000 (4,137)	15F51M24H4	20F51M4H4	20F51M6H4	20F51M9H4	20F51M12H4	20F51M16H4
3/8	H6	60,000 (4,137)	15F51M24H6	20F51M4H6	20F51M6H6	20F51M9H6	20F51M12H6	20F51M16H6
9/16	H9	60,000 (4,137)	15F51M24H9	20F51M4H9	20F51M6H9	20F51M9H9	20F51M12H9	20F51M16H9
Ultra-High Pressure			Ultra-High Pressure					
1/4	U4	100,000 (6,896)	15F51M24U4	20F51M4U4	20F51M6U4	20F51M9U4	20F51M12U4	20F51M16U4
3/8	U6	100,000 (6,896)	15F51M24U6	20F51M4U6	20F51M6U6	20F51M9U6	20F51M12U6	20F51M16U6
9/16	U9	100,000 (6,896)	15F51M24U9	20F51M4U9	20F51M6U9	20F51M9U9	20F51M12U9	20F51M16U9
5/16	U5	150,000 (10,344)	15F51M24U5	20F51M4U5	20F51M6U5	20F51M9U5	20F51M12U5	20F51M16U5

\* The pressure rating of any adapter is the value of the lowest rated connection in the fitting.

# Medium Pressure—Adapters (Male to Female)

## Model Data

Male			Female			
O.D. Size in.	Connection Type	Connection Type	43,000psi (2,965bar)	60,000psi (4,137bar)		
			1" M16H	1/4" H4	3/8" H6	9/16" H9
			High-Pressure			
Medium-Pressure						
1-1/2	M24	15,000 (1,034)	15F51M16HM24	15F51H4M24	15F51H6M24	15F51H9M24
1/4	M4	20,000 (1,379)	20F51M16HM4	20F51H4M4	20F51H6M4	20F51H9M4
3/8	M6	20,000 (1,379)	20F51M16HM6	20F51H4M6	20F51H6M6	20F51H9M6
9/16	M9	20,000 (1,379)	20F51M16HM9	20F51H4M9	20F51H6M9	20F51H9M9
3/4	M12	20,000 (1,379)	20F51M16HM12	20F51H4M12	20F51H6M12	20F51H9M12
1	M16	20,000 (1,379)	20F51M16HM16	20F51H4M16	20F51H6M16	20F51H9M16



- Needle Valves
- Check Valves
- Relief Valves
- Filters
- Fittings
- Adapters and Couplings
- Adapters (Male to Female)
- Couplings (Female to Female)
- Adapters (Male to Male)
- Tubing

Male			Female			
O.D. Size in.	Connection Type	Connection Type	100,000psi (6,896bar)			150,000psi (10,344bar)
			1/4" U4	3/8" U6	9/16" U9	5/16" U5
			Ultra-High Pressure			
Medium-Pressure						
1-1/2	M24	15,000 (1,034)	15F51U4M24	15F51U6M24	15F51U9M24	15F51U5M24
1/4	M4	20,000 (1,379)	20F51U4M4	20F51U6M4	20F51U9M4	20F51U5M4
3/8	M6	20,000 (1,379)	20F51U4M6	20F51U6M6	20F51U9M6	20F51U5M6
9/16	M9	20,000 (1,379)	20F51U4M9	20F51U6M9	20F51U9M9	20F51U5M9
3/4	M12	20,000 (1,379)	20F51U4M12	20F51U6M12	20F51U9M12	20F51U5M12
1	M16	20,000 (1,379)	20F51U4M16	20F51U6M16	20F51U9M16	20F51U5M16

\* The pressure rating of any adapter is the value of the lowest rated connection in the fitting.

# Medium Pressure—Couplings (Female to Female)

## Selection Example

20		F52		M12		H6	
Pressure Rating		Component Type		Female Size		Female Size	
15 (only M24)	15,000psi	F52	Couplings (Female to Female)	M4	1/4"	M4, H4, U4-1/4"	
20	20,000psi			M6	3/8"	U5-5/16"	
				M9	9/16"	M6, H6, U6-3/8"	
				M12	3/4"	M9, H9, U9-9/16"	
				M16	1"	M12-3/4"	
				M24	1-1/2" (only 15 series)	M16-1"	
						M16H-1" (43 series)	
						M24-1-1/2" (only 15 series)	

-  Medium Pressure
- Needle Valves
- Check Valves
- Relief Valves
- Filters
- Fittings
- Adapters and Couplings**
- Adapters (Male to Female)
- Couplings (Female to Female)**
- Adapters (Male to Male)
- Tubing

## Model Data

Female			Female					
O.D. Size in.	Connection Type	Max. Pressure psi (bar)*	15,000psi (1,034bar)	20,000psi (1,379bar)				
			1-1/2" M24	1/4" M4	3/8" M6	9/16" M9	3/4" M12	1" M16
Medium-Pressure			Medium-Pressure					
1-1/2	M24	15,000 (1,034)		15F52M24M4	15F52M24M6	15F52M24M9	15F52M24M12	15F52M24M16
1/4	M4	20,000 (1,379)	15F52M24M4		20F52M4M6	20F52M4M9	20F52M4M12	20F52M4M16
3/8	M6	20,000 (1,379)	15F52M24M6			20F52M6M9	20F52M6M12	20F52M6M16
9/16	M9	20,000 (1,379)	15F52M24M9				20F52M9M12	20F52M9M16
3/4	M12	20,000 (1,379)	15F52M24M12					20F52M12M16
1	M16	20,000 (1,379)	15F52M24M16					

\* The pressure rating of any adapter is the value of the lowest rated connection in the fitting.

# Medium Pressure—Couplings (Female to Female)

## Model Data

Female			Female			
O.D. Size in.	Connection Type	Max. Pressure psi (bar)*	43,000psi (2,965bar)	60,000psi (4,137bar)		
			1-1/2" M16H	1/4" H4	3/8" H6	9/16" H9
Medium-Pressure			High-Pressure			
1/4	M4	20,000 (1,379)	20F52M4M16H	20F52M4H4	20F52M4H6	20F52M4H9
3/8	M6	20,000 (1,379)	20F52M6M16H	20F52M6H4	20F52M6H6	20F52M6H9
9/16	M9	20,000 (1,379)	20F52M9M16H	20F52M9H4	20F52M9H6	20F52M9H9
3/4	M12	20,000 (1,379)	20F52M12M16H	20F52M12H4	20F52M12H6	20F52M12H9
1	M16	20,000 (1,379)	20F52M16M16H	20F52M16H4	20F52M16H6	20F52M16H9

Female			Female			
O.D. Size in.	Connection Type	Max. Pressure psi (bar)*	100,000psi (6,896bar)			150,000psi (10,344bar)
			1/4" U4	9/16" U9	3/8" U6	5/16" U5
Medium-Pressure			Ultra-High Pressure			
1/4	M4	20,000 (1,379)	20F52M4U4	20F52M4U9	20F52M4U6	20F52M4U5
3/8	M6	20,000 (1,379)	20F52M6U4	20F52M6U9	20F52M6U6	20F52M6U5
9/16	M9	20,000 (1,379)	20F52M9U4	20F52M9U9	20F52M9U6	20F52M9U5
3/4	M12	20,000 (1,379)	20F52M12U4	20F52M12U9	20F52M12U6	20F52M12U5
1	M16	20,000 (1,379)	20F52M16U4	20F52M16U9	20F52M16U6	20F52M16U5

\* The pressure rating of any adapter is the value of the lowest rated connection in the fitting.

-  Medium Pressure
- Needle Valves
- Check Valves
- Relief Valves
- Filters
- Fittings
- Adapters and Couplings
- Adapters (Male to Female)
- Couplings (Female to Female)
- Adapters (Male to Male)
- Tubing

Pressure to 20,000psi (1,379bar)

# Medium Pressure—Adapters (Male to Male)

## Selection Example

20		F53		M6		M9	
Pressure Rating		Component Type		Male Size		Male Size	
15 (only M24)	15,000psi	F53	Adapters (Male to Male)	M4	1/4"	M4, H4, U4-1/4"	
20	20,000psi			M6	3/8"	U5-5/16"	
				M9	9/16"	M6, H6, U6-3/8"	
				M12	3/4"	M9, H9, U9-9/16"	
				M16	1"	M12-3/4"	
				M24	1-1/2" (only 43 series)	M16-1"	
						M16H-1" (43 series)	
						M24-1-1/2" (only 43 series)	

-  Medium Pressure
- Needle Valves
- Check Valves
- Relief Valves
- Filters
- Fittings
- Adapters and Couplings**
- Adapters (Male to Female)
- Couplings (Female to Female)
- Adapters (Male to Male)**
- Tubing

## Model Data

Male			Male					
O.D. Size in.	Connection Type	Max. Pressure psi (bar)*	15,000psi (1,034bar)	20,000psi (1,379bar)				
			1-1/2" M24	1/4" M4	3/8" M6	9/16" M9	3/4" M12	1" M16
Medium-Pressure			Medium-Pressure					
1-1/2	M24	15,000 (1,034)	15F53M24	15F53M24M4	15F53M24M6	15F53M24M9	15F53M24M12	15F53M24M16
1/4	M4	20,000 (1,379)	15F53M24M4	20F53M4	20F53M4M6	20F53M4M9	20F53M4M12	20F53M4M16
3/8	M6	20,000 (1,379)	15F53M24M6		20F53M6	20F53M6M9	20F53M6M12	20F53M6M16
9/16	M9	20,000 (1,379)	15F53M24M9			20F53M9	20F53M9M12	20F53M9M16
3/4	M12	20,000 (1,379)	15F53M24M12				20F53M12	20F53M12M16
1	M16	20,000 (1,379)	15F53M24M16					20F53M16

\* The pressure rating of any adapter is the value of the lowest rated connection in the fitting.

# Medium Pressure—Adapters (Male to Male)

## Model Data

Male			Male			
O.D. Size in.	Connection Type	Max. Pressure psi (bar)*	43,000psi (2,965bar)	60,000psi (4,137bar)		
			1-1/2" M16H	1/4" H4	3/8" H6	9/16" H9
Medium-Pressure			High-Pressure			
1-1/2	M24	15,000 (1,034)	15F53M24M16H	15F53M24H4	15F53M24H6	15F53M24H9
1/4	M4	20,000 (1,379)	20F53M4M16H	20F53M4H4	20F53M4H6	20F53M4H9
3/8	M6	20,000 (1,379)	20F53M6M16H	20F53M6H4	20F53M6H6	20F53M6H9
9/16	M9	20,000 (1,379)	20F53M9M16H	20F53M9H4	20F53M9H6	20F53M9H9
3/4	M12	20,000 (1,379)	20F53M12M16H	20F53M12H4	20F53M12H6	20F53M12H9
1	M16	20,000 (1,379)	20F53M16M16H	20F53M16H4	20F53M16H6	20F53M16H9

Male			Male			
O.D. Size in.	Connection Type	Max. Pressure psi (bar)*	100,000psi (6,896bar)			150,000psi (10,344bar)
			1/4" U4	9/16" U9	3/8" U6	5/16" U5
Medium-Pressure			Ultra-High Pressure			
1-1/2	M24	15,000 (1,034)	15F53M24U4	15F53M24U6	15F53M24U9	15F53M24U5
1/4	M4	20,000 (1,379)	20F53M4U4	20F53M4U6	20F53M4U9	20F53M4U5
3/8	M6	20,000 (1,379)	20F53M6U4	20F53M6U6	20F53M6U9	20F53M6U5
9/16	M9	20,000 (1,379)	20F53M9U4	20F53M9U6	20F53M9U9	20F53M9U5
3/4	M12	20,000 (1,379)	20F53M12U4	20F53M12U6	20F53M12U9	20F53M12U5
1	M16	20,000 (1,379)	20F53M16U4	20F53M16U6	20F53M16U9	20F53M16U5

\* The pressure rating of any adapter is the value of the lowest rated connection in the fitting.

-  Medium Pressure
- Needle Valves
- Check Valves
- Relief Valves
- Filters
- Fittings
- Adapters and Couplings
  - Adapters (Male to Female)
  - Couplings (Female to Female)
  - Adapters (Male to Male)
- Tubing



### Tubing

HiFluid supplies a complete range of medium-pressure tubing for connections between components. Made from high-strength cold-drawn seamless 316SS, the tubing offers excellent pressure resistance and connection reliability under medium-pressure conditions. It meets the nickel-content requirements of GB 50156-2021 for hydrogen refueling facilities.

HiFluid can also provide cone-threaded tubing on request for rapid connections or customized installations in medium-pressure systems. A full range of sizes is available, and thread forms and lengths can be customized to meet diverse installation requirements.



Medium Pressure

Needle Valves

Check Valves

Relief Valves

Filters

Fittings

Adapters and Couplings

Tubing

Tubing

### Dimensions

O.D. Size in. (mm)	Tolerance O.D in. (mm)
1-1/2 (38.1)	1.495/1.490 (37.98/37.85)
1/4 (6.35)	0.248/0.243 (6.299/6.172)
3/8 (9.53)	0.370/0.365 (9.398/9.271)
9/16 (14.29)	0.557/0.552 (14.147/14.021)
3/4 (19.05)	0.745/0.740 (18.923/18.796)
1 (25.4)	0.995/0.990 (25.273/25.174)

### Model Data

Type	Tube Material	Connection Type	Tube Size in. (mm)		Working Pressure psi (bar)				
			O.D.	I.D.	-198°C to 37°C (-325°F to 100°F)	93°C (200°F)	204°C (400°F)	315°C (600°F)	426°C (799°F)
20T4-316	316SS	M4F	1/4 (6.35)	0.109 (2.77)	20,000 (1,379)	18,900 (1,303)	17,430 (1,202)	15,960 (1,100)	15,120 (1,042)
20T6-316	316SS	M6F	3/8 (9.53)	0.203 (5.17)	20,000 (1,379)	18,900 (1,303)	17,430 (1,202)	15,960 (1,100)	15,120 (1,042)
20T9-316	316SS	M9F	9/16 (14.29)	0.312 (7.93)	20,000 (1,379)	18,900 (1,303)	17,430 (1,202)	15,960 (1,100)	15,120 (1,042)
15T9-316	316SS	M9F	9/16 (14.29)	0.359 (9.12)	15,000 (1,034)	13,680 (943)	12,616 (870)	11,552 (796)	10,944 (755)
20T12-316	316SS	M12F	3/4 (19.05)	0.438 (11.13)	20,000 (1,379)	18,900 (1,303)	17,430 (1,202)	15,960 (1,100)	15,120 (1,042)
15T12-316	316SS	M12F	3/4 (19.05)	0.516 (13.11)	15,000 (1,034)	13,680 (943)	12,616 (870)	11,552 (796)	10,944 (755)
20T16-316	316SS	M16F	1 (25.4)	0.562 (14.27)	20,000 (1,379)	18,900 (1,303)	17,430 (1,202)	15,960 (1,100)	15,120 (1,042)
15T16-316	316SS	M16F	1 (25.4)	0.688 (17.48)	15,000 (1,034)	13,680 (943)	12,616 (870)	11,552 (796)	10,944 (755)
15T24-316	316SS	M24F	1-1/2 (38.1)	0.937 (23.8)	15,000 (1,034)	13,680 (943)	12,616 (870)	11,552 (796)	10,944 (755)

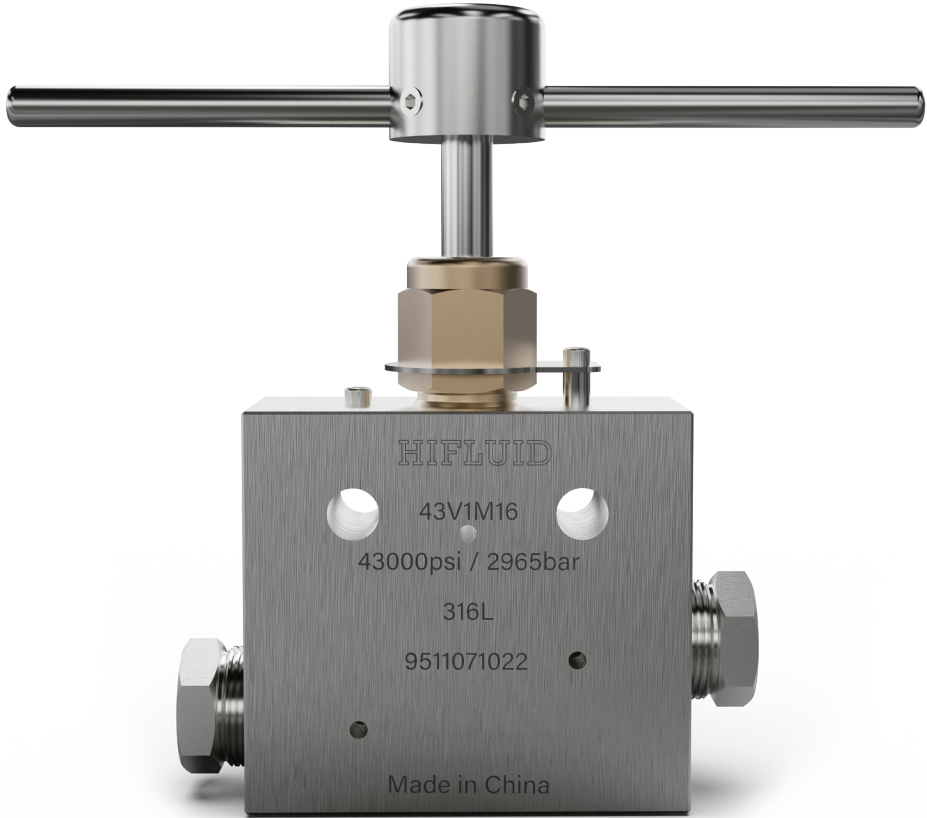

- Low Pressure
- Medium Pressure
- High Pressure
- Ultra-High Pressure
- Technical Information

# High Pressure

to 30,000psi (2,068bar), 43,000psi (2,965bar), 60,000psi (4,137bar)

HiFluid's high-pressure product portfolio comprises needle valves (hand-operated), actuator needle valves, check valves, relief valves, filters, fittings and tubing. All valve and fitting interfaces adopt the cone-and-thread connection, providing excellent sealing performance and stable pressure resistance.

# High Pressure—Needle Valves



## Needle Valves (Hand-Operated)

A needle valve controls gas or liquid flow by manually adjusting the stem travel. Precision flow-control models are available as required.

HiFluid offers a complete range of needle valves; selected models feature replaceable seats to simplify maintenance and reduce cost. All valves are supplied with glands and collars to ensure reliable connection and sealing.

Each valve body is laser-etched with model, serial number, maximum working pressure, and primary material to ensure full traceability and compliance with standardized quality control.

### Features

- Non-rotating rising stem design minimizes wear between needle and seat, extending service life.
- High-strength stainless steel duplex wetted parts and 17-4PH stem for outstanding mechanical strength and excellent corrosion resistance.
- Metal-to-metal seating provides long-term stability under high pressure and frequent cycling.
- A safety weep hole is provided between the connection and the sealing surface for leak detection and pressure release.



### Needle Valves

- Hand-Operated Actuator
- Check Valves
- Relief Valves
- Filters
- Fittings
- Adapters and Couplings
- Tubing

## Actuator Needle Valves

An actuator needle valve uses an air actuator to open/close the needle for remote automation. The piston-type actuator runs smoothly with fast response, suitable for a variety of industrial automation scenarios.

HiFluid offers both normally-open (NO) and normally-closed (NC) versions to match system logic. Actuators are available in light- and heavy-duty versions to accommodate different driving pressures.

### Features

- Actuators are made of anodized aluminum, which provides good corrosion resistance.
- Mechanical position indicator provided as standard; optional limit switches are available for remote monitoring or system integration.
- Spring-return design as standard; double-acting construction available according to application requirements.
- Except for the actuator, all performance characteristics are identical to the hand-operated needle valves.



Pressure to 30,000psi (2,068bar), 43,000psi (2,965bar), 60,000psi (4,137bar)

# High Pressure—Needle Valves (Hand-Operated)

## Selection Example

30		V1		H4		-B	
Pressure Rating		Body Pattern		Connection Size		Options	
30	30,000psi	V1	2-Way Straight	H4	1/4"	B	Cryogenic Packing -73°C (-100°F)
43 (only M16H)	43,000psi	V2	2-Way Angle	H6	3/8"	GY	Graphite Braided Yarn Packing 426°C (799°F)
60	60,000psi	V3	3-Way, 2 on Pressure	H9	9/16"	HT	High Temperature Option 649°C (1200°F)
		V4	3-Way, 1 on Pressure	M16H	1" (only 43 series)	LT	Low Temperature Option -253°C (-423°F)
		V5	3-Way, 2-Stem Manifold			TG	Teflon Glass Packing 315°C (600°F)
						H2	Hydrogen Service
						R	Regulating Stem
						RC	Regulating Stem with Replaceable Seat
						C	Vee Stem with Replaceable Seat



High Pressure

- Needle Valves
- Hand-Operated
- Actuator
- Check Valves
- Relief Valves
- Filters
- Fittings
- Adapters and Couplings
- Tubing

# High Pressure—Needle Valves (Hand-Operated)

## Flow Coefficient

O.D. Size in.(mm)	Connection Type	Orifice Size in.(mm)	Rated (Cv*)	Pressure Rating @R.T. (psi (bar))**
1/4 (6.35)	H4F	0.094 (2.3)	0.12	30,000 (2,068)
3/8 (9.53)	H6F	0.125 (3.2)	0.23	30,000 (2,068)
9/16 (14.29)	H9F	0.125 (3.2)	0.33	30,000 (2,068)
1 (25.4)	M16HF	0.438 (11.1)	2.6	43,000 (2,965)
1/4 (6.35)	H4F	0.062 (1.6)	0.08	60,000 (4,137)
3/8 (9.53)	H6F	0.062 (1.6)	0.09	60,000 (4,137)
9/16 (14.29)	H9F	0.078 (2)	0.14	60,000 (4,137)

-  High Pressure
- Needle Valves
- Hand-Operated
- Actuator
- Check Valves
- Relief Valves
- Filters
- Fittings
- Adapters and Couplings
- Tubing

## Flow Curve

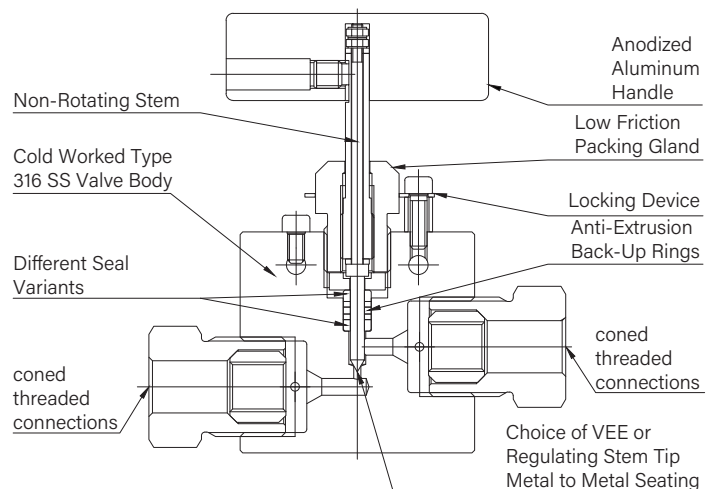
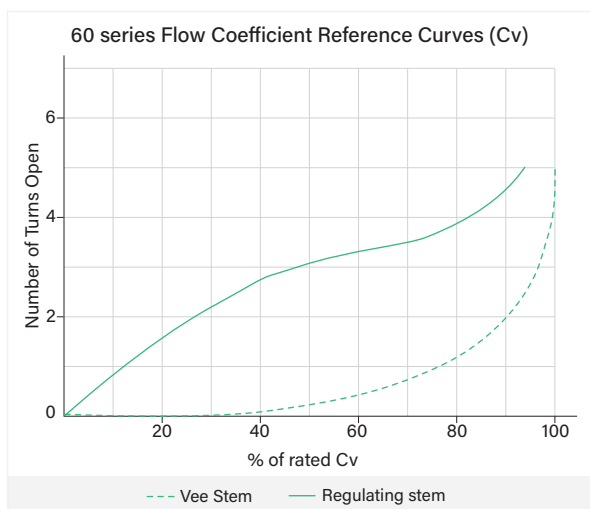
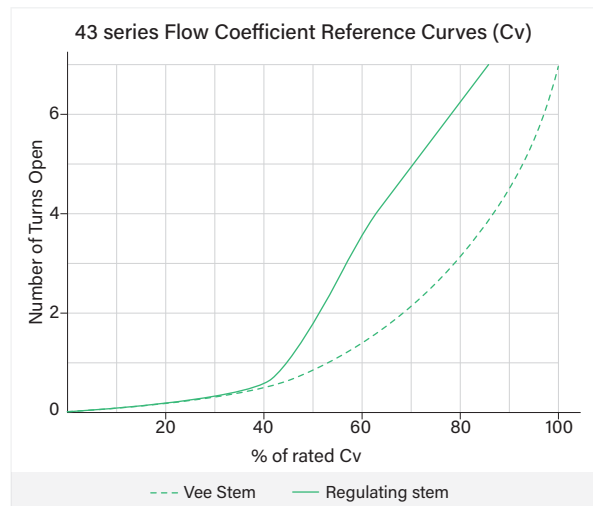
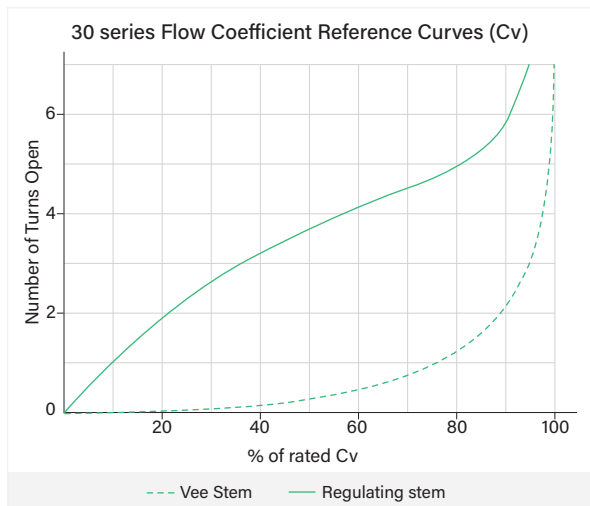

\* Cv values shown are for 2-way straight pattern vee stem valves. For 2-way angle patterns, increase the Cv value by 50%.

\*\* For the pressure-temperature relationship, refer to the guidance in the "Technical Information" section.

# High Pressure—Needle Valves (Hand-Operated)

## Dimensions

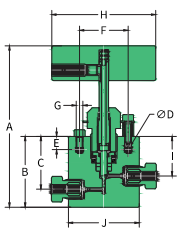
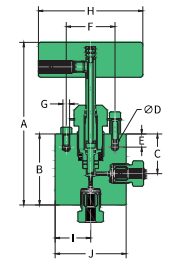
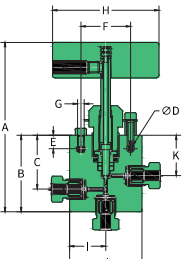
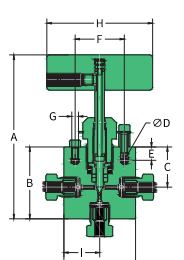
Valve Pattern	Type	O.D. Size in.	Orifice in. (mm)	Dimensions in. (mm)										Valve Panel Hole	Block Thick- ness
				A	B	C	D	E	F	H	I	J	K		
<b>2-Way Straight</b>															
	30V1H4	1/4	0.094 (2.3)	4.76 (121)	2.01 (51)	1.50 (38)	0.22 (5.5)	0.37 (9.5)	1.38 (35)	2.95 (75)	1.12 (28.5)	2.01 (51)		1.00 (25.4)	1.02 (26)
	30V1H6	3/8	0.094 (2.3)	4.76 (121)	2.01 (51)	1.50 (38)	0.22 (5.5)	0.37 (9.5)	1.38 (35)	2.95 (75)	1.12 (28.5)	2.01 (51)		1.00 (25.4)	1.02 (26)
	30V1H9	9/16	0.125 (3.2)	5.20 (132)	2.44 (62)	1.56 (39.6)	0.22 (5.5)	0.37 (9.5)	1.38 (35)	2.95 (75)	1.12 (28.5)	2.64 (67)		1.00 (25.4)	1.54 (39)
<b>2-Way Angle</b>															
	30V2H4	1/4	0.094 (2.3)	4.76 (121)	2.01 (51)	1.12 (28.5)	0.22 (5.5)	0.37 (9.5)	1.38 (35)	2.95 (75)	1.00 (25.4)	2.01 (51)		1.00 (25.4)	1.02 (26)
	30V2H6	3/8	0.125 (3.2)	4.96 (126)	2.20 (56)	1.10 (28)	0.22 (5.5)	0.37 (9.5)	1.38 (35)	2.95 (75)	1.00 (25.4)	2.01 (51)		1.00 (25.4)	1.02 (26)
	30V2H9	9/16	0.125 (3.2)	5.20 (132)	2.44 (62)	1.12 (28.5)	0.22 (5.5)	0.37 (9.5)	1.38 (35)	2.95 (75)	1.32 (33.5)	2.64 (67)		1.00 (25.4)	1.54 (39)
<b>3-Way, 2 on Pressure</b>															
	30V3H4	1/4	0.094 (2.3)	4.89 (124)	2.13 (54.1)	1.50 (38)	0.22 (5.5)	0.37 (9.5)	1.38 (35)	2.95 (75)	1.00 (25.4)	2.01 (51)	1.12 (28.5)	1.00 (25.4)	1.02 (26)
	30V3H6	3/8	0.125 (3.2)	5.26 (133.5)	2.5 (63.5)	1.50 (38)	0.22 (5.5)	0.37 (9.5)	1.38 (35)	2.95 (75)	1.00 (25.4)	2.01 (51)	1.12 (28.5)	1.00 (25.4)	1.02 (26)
	30V3H9	9/16	0.125 (3.2)	5.63 (143)	2.87 (72.9)	1.56 (39.6)	0.22 (5.5)	0.37 (9.5)	1.38 (35)	2.95 (75)	1.32 (33.5)	2.64 (67)	1.12 (28.5)	1.00 (25.4)	1.54 (39)
<b>3-Way, 1 on Pressure</b>															
	30V4H4	1/4	0.094 (2.3)	4.76 (121)	2.01 (51)	1.12 (28.5)	0.22 (5.5)	0.37 (9.5)	1.38 (35)	2.95 (75)	1.00 (25.4)	2.01 (51)		1.00 (25.4)	1.02 (26)
	30V4H6	3/8	0.125 (3.2)	4.90 (124.5)	2.20 (56)	1.12 (28.5)	0.22 (5.5)	0.37 (9.5)	1.38 (35)	2.95 (75)	1.00 (25.4)	2.01 (51)		1.00 (25.4)	1.02 (26)
	30V4H9	9/16	0.125 (3.2)	5.20 (132)	2.44 (62)	1.12 (28.5)	0.22 (5.5)	0.37 (9.5)	1.38 (35)	2.95 (75)	1.32 (33.5)	2.64 (67)		1.00 (25.4)	1.54 (39)

Note: Dimensions are for reference only; contact HiFluid for further requirements.

-  High Pressure
- Needle Valves
- Hand-Operated
- Actuator
- Check Valves
- Relief Valves
- Filters
- Fittings
- Adapters and Couplings
- Tubing

Pressure to 30,000psi (2,068bar), 43,000psi (2,965bar), 60,000psi (4,137bar)

# High Pressure—Needle Valves (Hand-Operated)

## Dimensions

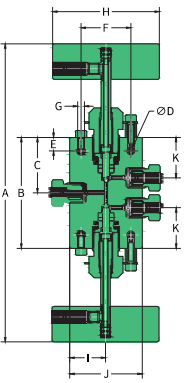
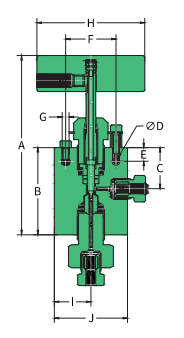
Valve Pattern	Type	O.D. Size in.	Orifice in. (mm)	Dimensions in. (mm)										Valve Panel Hole	Block Thickness
				A	B	C	D	E	F	H	I	J	K		
<b>3-Way, 2-Stem Manifold</b>															
	30V5H4	1/4	0.094 (2.3)	8.54 (217)	3.07 (78)	1.54 (39.1)	0.22 (5.5)	0.37 (9.5)	1.38 (35)	2.95 (75)	1.00 (25.4)	1.00 (25.4)	1.12 (28.5)	1.00 (25.4)	1.02 (26)
	30V5H6	3/8	0.125 (3.2)	8.72 (221.5)	3.25 (82.5)	1.63 (41.5)	0.22 (5.5)	0.37 (9.5)	1.38 (35)	2.95 (75)	1.00 (25.4)	1.00 (25.4)	1.12 (28.5)	1.00 (25.4)	1.02 (26)
	30V5H9	9/16	0.125 (3.2)	9.21 (234)	3.74 (95)	1.88 (47.8)	0.22 (5.5)	0.37 (9.5)	1.38 (35)	2.95 (75)	1.00 (25.4)	1.00 (25.4)	1.12 (28.5)	1.00 (25.4)	1.54 (39)
<b>2-Way Angle (Replaceable Seat)</b>															
	30V2H4-C	1/4	0.094 (2.3)	4.96 (126)	2.38 (60.5)	1.12 (28.5)	0.22 (5.5)	0.37 (9.5)	1.38 (35)	2.95 (75)	1.12 (28.5)	2.01 (51)	1.12 (28.5)	1.00 (25.4)	1.02 (26)
	30V2H6-C	3/8	0.125 (3.2)	4.96 (126)	2.38 (60.5)	1.12 (28.5)	0.22 (5.5)	0.37 (9.5)	1.38 (35)	2.95 (75)	1.12 (28.5)	2.01 (51)	1.12 (28.5)	1.00 (25.4)	1.02 (26)
	30V2H9-C	9/16	0.125 (3.2)	4.93 (125)	2.44 (62)	1.18 (30)	0.22 (5.5)	0.37 (9.5)	1.38 (35)	2.95 (75)	1.32 (33.5)	2.64 (67)	1.12 (28.5)	1.00 (25.4)	1.54 (39)

Note: Dimensions are for reference only; contact HiFluid for further requirements.

-  High Pressure
- Needle Valves
- Hand-Operated
- Actuator
- Check Valves
- Relief Valves
- Filters
- Fittings
- Adapters and Couplings
- Tubing

# High Pressure—Needle Valves (Hand-Operated)

## Dimensions

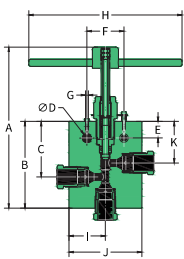
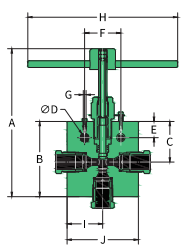
Valve Pattern	Type	O.D. Size in.	Orifice in. (mm)	Dimensions in. (mm)										Valve Panel Hole	Block Thickness
				A	B	C	D	E	F	H	I	J	K		
<b>2-Way Straight</b>															
	43V1M16	1	0.438 (11.1)	9.472 (240)	4.45 (113)	3.50 (88.9)	0.571 (14.5)	1.122 (28.5)	2.50 (63.5)	10.35 (263)	2.736 (69.5)	4.921 (125)		1.614 (41)	2.244 (57)
<b>2-Way Angle</b>															
	43V2M16	1	0.438 (11.1)	4.76 (121)	5.12 (130)	3.50 (88.9)	0.571 (14.5)	1.122 (28.5)	2.50 (63.5)	10.35 (263)	2.431 (62.5)	4.921 (125)		1.614 (41)	2.244 (57)
<b>3-Way, 2 on Pressure</b>															
	43V3M16	1	0.438 (11.1)	10.19 (259)	5.87 (149)	3.75 (95.3)	0.571 (14.5)	1.122 (28.5)	2.50 (63.5)	10.35 (263)	2.431 (62.5)	4.921 (125)	2.81 (71.4)	1.614 (41)	2.244 (57)
<b>3-Way, 1 on Pressure</b>															
	43V4M16	1	0.438 (11.1)	9.52 (242)	5.20 (132)	2.81 (71.4)	0.571 (14.5)	1.122 (28.5)	2.50 (63.5)	10.35 (263)	2.431 (62.5)	4.921 (125)		1.614 (41)	2.244 (57)

Note: Dimensions are for reference only; contact HiFluid for further requirements.

-  High Pressure
- Needle Valves
- Hand-Operated
- Actuator
- Check Valves
- Relief Valves
- Filters
- Fittings
- Adapters and Couplings
- Tubing

Pressure to 30,000psi (2,068bar), 43,000psi (2,965bar), 60,000psi (4,137bar)

# High Pressure—Needle Valves (Hand-Operated)

**HIFLUID**

## Dimensions

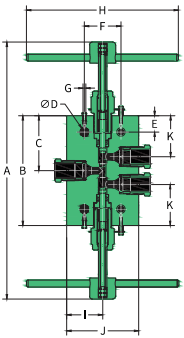
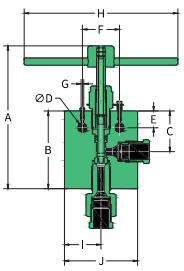
Valve Pattern	Type	O.D. Size in.	Orifice in. (mm)	Dimensions in. (mm)										Valve Panel Hole	Block Thickness
				A	B	C	D	E	F	H	I	J	K		
<b>3-Way, 2-Stem Manifold</b>															
	43V5M16	1	0.438 (11.1)	16.18 (411)	7.52 (191)	3.76 (95.5)	0.571 (14.5)	1.122 (28.5)	2.50 (63.5)	10.35 (263)	2.431 (62.5)	4.921 (125)	2.81 (71.4)	1.614 (41)	2.244 (57)
<b>2-Way Angle (Replaceable Seat)</b>															
	43V2M16-C	1	0.438 (11.1)	9.61 (244)	5.25 (133)	2.81 (71.4)	0.571 (14.5)	1.122 (28.5)	2.50 (63.5)	10.35 (263)	2.431 (62.5)	4.921 (125)		1.614 (41)	2.244 (57)

Note: Dimensions are for reference only; contact HiFluid for further requirements.

-  High Pressure
- Needle Valves
- Hand-Operated
- Actuator
- Check Valves
- Relief Valves
- Filters
- Fittings
- Adapters and Couplings
- Tubing

# High Pressure—Needle Valves (Hand-Operated)

## Dimensions

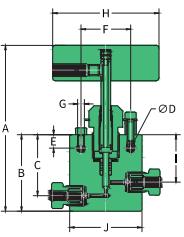
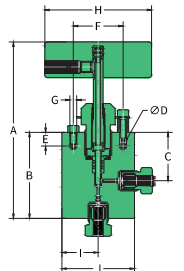
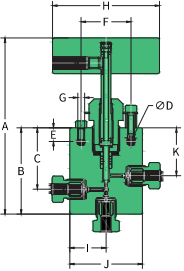
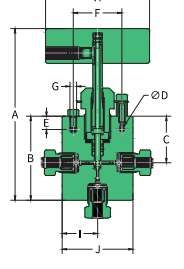
Valve Pattern	Type	O.D. Size in.	Orifice in. (mm)	Dimensions in. (mm)										Valve Panel Hole	Block Thickness
				A	B	C	D	E	F	H	I	J	K		
<b>2-Way Straight</b>															
	60V1H4	1/4	0.062 (1.6)	4.76 (121)	2.13 (54.1)	1.69 (43)	0.22 (5.5)	0.37 (9.5)	1.38 (35)	2.95 (75)	1.32 (33.5)	2.01 (51)		1.00 (25.4)	1.02 (26)
	60V1H6	3/8	0.062 (1.6)	4.76 (121)	2.24 (56.9)	1.69 (43)	0.22 (5.5)	0.37 (9.5)	1.38 (35)	2.95 (75)	1.32 (33.5)	2.01 (51)		1.00 (25.4)	1.02 (26)
	60V1H9	9/16	0.078 (2)	5.20 (132)	2.50 (63.5)	1.75 (44.5)	0.22 (5.6)	0.37 (9.5)	1.38 (35)	2.95 (75)	1.30 (33)	2.64 (67)		1.00 (25.4)	1.54 (39)
<b>2-Way Angle</b>															
	60V2H4	1/4	0.062 (1.6)	4.96 (126)	2.38 (60.5)	1.34 (34)	0.22 (5.5)	0.37 (9.5)	1.38 (35)	2.95 (75)	1.00 (25.4)	2.01 (51)		1.00 (25.4)	1.02 (26)
	60V2H6	3/8	0.062 (1.6)	5.16 (131)	2.62 (66.5)	1.32 (33.5)	0.22 (5.5)	0.37 (9.5)	1.38 (35)	2.95 (75)	1.00 (25.4)	2.01 (51)		1.00 (25.4)	1.02 (26)
	60V2H9	9/16	0.078 (2)	5.35 (136)	2.80 (71.1)	1.32 (33.5)	0.22 (5.6)	0.37 (9.5)	1.38 (35)	2.95 (75)	1.32 (33.5)	2.64 (67)		1.00 (25.4)	1.54 (39)
<b>3-Way, 2 on Pressure</b>															
	60V3H4	1/4	0.062 (1.6)	4.96 (126)	2.38 (60.5)	1.69 (43)	0.22 (5.5)	0.37 (9.5)	1.38 (35)	2.95 (75)	1.00 (25.4)	2.01 (51)	1.12 (28.5)	1.00 (25.4)	1.02 (26)
	60V3H6	3/8	0.062 (1.6)	2.76 (70.1)	5.33 (135.4)	1.69 (43)	0.22 (5.5)	0.37 (9.5)	1.38 (35)	2.95 (75)	1.00 (25.4)	2.01 (51)	1.12 (28.5)	1.00 (25.4)	1.02 (26)
	60V3H9	9/16	0.078 (2)	3.15 (80)	5.71 (145)	1.75 (44.5)	0.22 (5.6)	0.37 (9.5)	1.38 (35)	2.95 (75)	1.32 (33.5)	2.64 (67)	1.12 (28.5)	1.00 (25.4)	1.54 (39)
<b>3-Way, 1 on Pressure</b>															
	60V4H4	1/4	0.062 (1.6)	4.96 (126)	2.38 (60.5)	1.32 (33.5)	0.22 (5.5)	0.37 (9.5)	1.38 (35)	2.95 (75)	1.00 (25.4)	2.01 (51)		1.00 (25.4)	1.02 (26)
	60V4H6	3/8	0.062 (1.6)	5.16 (131)	2.62 (66.5)	1.32 (33.5)	0.22 (5.5)	0.37 (9.5)	1.38 (35)	2.95 (75)	1.00 (25.4)	2.01 (51)		1.00 (25.4)	1.02 (26)
	60V4H9	9/16	0.078 (2)	5.35 (136)	2.80 (71.1)	0.062 (1.6)	0.22 (5.6)	0.37 (9.5)	1.38 (35)	2.95 (75)	1.32 (33.5)	2.64 (67)		1.00 (25.4)	1.54 (39)

Note: Dimensions are for reference only; contact HiFluid for further requirements.

-  High Pressure
- Needle Valves
- Hand-Operated
- Actuator
- Check Valves
- Relief Valves
- Filters
- Fittings
- Adapters and Couplings
- Tubing

Pressure to 30,000psi (2,068bar), 43,000psi (2,965bar), 60,000psi (4,137bar)

# High Pressure—Needle Valves (Hand-Operated)

## Dimensions

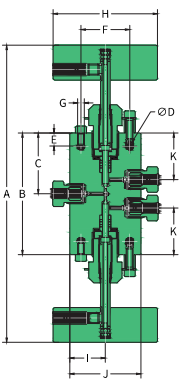
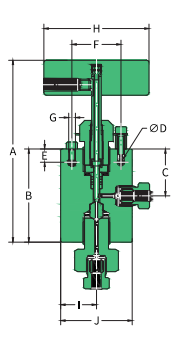
Valve Pattern	Type	O.D. Size in.	Orifice in. (mm)	Dimensions in. (mm)										Valve Panel Hole	Block Thickness
				A	B	C	D	E	F	H	I	J	K		
<b>3-Way, 2-Stem Manifold</b>															
	60V5H4	1/4	0.062 (1.6)	8.56 (217.4)	3.44 (87.4)	1.72 (43.7)	0.22 (5.5)	0.37 (9.5)	1.38 (35)	2.95 (75)	1.00 (25.4)	2.01 (51)	1.12 (28.5)	1.00 (25.4)	1.02 (26)
	60V5H6	3/8	0.062 (1.6)	8.56 (217.4)	3.76 (95.5)	1.89 (48)	0.22 (5.5)	0.37 (9.5)	1.38 (35)	2.95 (75)	1.00 (25.4)	2.01 (51)	1.12 (28.5)	1.00 (25.4)	1.02 (26)
	60V5H9	9/16	0.078 (2)	9.25 (235)	4.13 (105)	2.07 (52.6)	0.22 (5.6)	0.37 (9.5)	1.38 (35)	2.95 (75)	1.32 (33.5)	2.64 (67)	1.12 (28.5)	1.00 (25.4)	1.54 (39)
<b>2-Way Angle (Replaceable Seat)</b>															
	60V2H4-C	1/4	0.062 (1.6)	5.16 (131)	2.62 (66.5)	1.32 (33.5)	0.22 (5.5)	0.37 (9.5)	1.38 (35)	2.95 (75)	1.00 (25.4)	2.01 (51)		1.00 (25.4)	1.02 (26)
	60V2H6-C	3/8	0.062 (1.6)	5.16 (131)	2.62 (66.5)	1.32 (33.5)	0.22 (5.5)	0.37 (9.5)	1.38 (35)	2.95 (75)	1.00 (25.4)	2.01 (51)		1.00 (25.4)	1.02 (26)
	60V2H9-C	9/16	0.078 (2)	5.16 (131)	2.62 (66.5)	1.32 (33.5)	0.22 (5.6)	0.37 (9.5)	1.38 (35)	2.95 (75)	1.32 (33.5)	2.64 (67)		1.00 (25.4)	1.54 (39)

Note: Dimensions are for reference only; contact HiFluid for further requirements.

-  High Pressure
- Needle Valves
- Hand-Operated
- Actuator
- Check Valves
- Relief Valves
- Filters
- Fittings
- Adapters and Couplings
- Tubing

# High Pressure—Actuator Needle Valves

## Selection Example

30		V1		H4		-HNC		-GY	
Pressure Rating		Body Pattern		Connection Size		Actuator Type		Options	
30	30,000psi	V1	2-Way Straight	H4	1/4"	MNO	Light-Duty NO	B	Cryogenic Packing -73°C (-100°F)
60	60,000psi	V2	2-Way Angle	H6	3/8"	HNO	Heavy-Duty NO	GY	Graphite Braided Yarn Packing 426°C (799°F)
				H9	9/16"	MNC	Light-Duty NC	HT	High Temperature Option 649°C (1200°F)
						HNC	Heavy-Duty NC	LT	Low Temperature Option -253°C (-423°F)
						MDA	Light-Duty DA	TG	Teflon Glass Packing 315°C (600°F)
						HDA	Heavy-Duty DA	H2	Hydrogen Service

Note: For working pressure, please see "Technical Data".

-  High Pressure
- Needle Valves
- Hand-Operated
- Actuator**
- Normally-Open
- Normally-Closed
- Double-Acting
- Check Valves
- Relief Valves
- Filters
- Fittings
- Adapters and Couplings
- Tubing

Pressure to 30,000psi (2,068bar), 43,000psi (2,965bar), 60,000psi (4,137bar)

# High Pressure—Actuator Needle Valves—Normally-Open

**HIFLUID**

## Dimensions

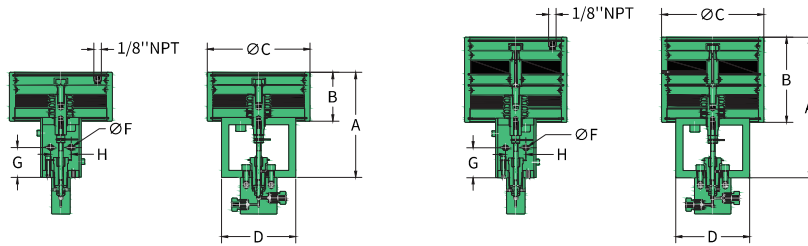

Actuator Type	Suffix	Piston Area in. <sup>2</sup> (mm <sup>2</sup> )	Dimensions in. (mm)						
			A	B	C	D	F	G	H
Light Duty	4;6;9-MNO	19.6 (12.645)	5.79 (147.3)	2.69 (68.3)	5.67 (144)	4.09 (104)	0.28 (7)	1.65 (42)	1.13 (28.8)
Heavy Duty	4;6;9-HNO	39.2 (25.290)	7.78 (197.8)	4.72 (119.9)	5.67 (144)	4.09 (104)	0.28 (7)	1.65 (42)	1.13 (28.8)

## Technical Data

Pre- ssure Rating	O.D. Size in.	Air Actuator		Air pressure required to close Valve at: System Pressure ksi (bar)										Max. Pressure psi (bar)	Stem Travel in. (mm)	Flow Coefficient Cv*
		Type	Suffix	1-12 (68-827)	14 (965)	16 (1,103)	18 (1,241)	20 (1,379)	22 (1,517)	24 (1,655)	26 (1,793)	28 (1,930)	30 (2,068)			
30	1/4	Light Duty	-MNO	25 (1.7)	25 (1.7)	30 (2.1)	35 (2.4)	35 (2.4)	40 (2.8)	45 (3.1)	50 (3.5)	50 (3.5)	55 (3.8)	30,000 (2,068)	0.19 (4.8)	0.12
		Heavy Duty	-HNO	15 (1)	15 (1)	15 (1)	20 (1.4)	20 (1.4)	20 (1.4)	25 (1.7)	25 (1.7)	25 (1.7)	30 (2.1)			
	3/8 9/16	Light Duty	-MNO	30 (2.1)	35 (2.4)	40 (2.8)	45 (3.1)	50 (3.5)	55 (3.8)	60 (4.2)	65 (4.9)	70 (4.9)	72 (5)	30,000 (2,068)	0.19 (4.8)	0.23
		Heavy Duty	-HNO	15 (1)	20 (1.4)	20 (1.4)	25 (1.7)	25 (1.7)	30 (2.1)	30 (2.1)	35 (2.4)	35 (2.4)	40 (2.8)			0.33

Pre- ssure Rating	O.D. Size in.	Air Actuator		Air pressure required to close Valve at: System Pressure ksi (bar)										Max. Pressure psi (bar)	Stem Travel in. (mm)	Flow Coefficient Cv*
		Type	Suffix	1-15 (68-1,034)	20 (1,379)	25 (1,724)	30 (2,068)	35 (2,413)	40 (2,758)	45 (3,103)	50 (3,447)	55 (3,792)	60 (4,137)			
60	1/4 3/8	Light Duty	-MNO	30 (2.1)	30 (2.1)	30 (2.1)	35 (2.4)	45 (3.1)	50 (3.5)	55 (3.8)	60 (4.2)	70 (4.9)	75 (5.2)	60,000 (4,137)	0.25 (6.4)	0.08
		Heavy Duty	-HNO	15 (1)	15 (1)	15 (1)	20 (1.4)	25 (1.7)	25 (1.7)	30 (2.1)	30 (2.1)	35 (2.4)	40 (2.8)			0.09
	9/16	Light Duty	-MNO	35 (2.4)	35 (2.4)	40 (2.8)	50 (3.5)	55 (3.8)	65 (4.5)	70 (5.2)	75 (5.2)	85 (5.9)	90 (6.2)	60,000 (4,137)	0.25 (6.4)	0.14
		Heavy Duty	-HNO	20 (1.4)	20 (1.4)	20 (1.4)	25 (1.7)	30 (2.1)	35 (2.4)	35 (2.8)	40 (2.8)	45 (3.1)	45 (3.1)			

- High Pressure
- Needle Valves
- Hand-Operated Actuator
- Normally-Open
- Normally-Closed
- Double-Acting
- Check Valves
- Relief Valves
- Filters
- Fittings
- Adapters and Couplings
- Tubing

Pressure to 30,000psi (2,068bar), 43,000psi (2,965bar), 60,000psi (4,137bar)

# High Pressure—Actuator Needle Valves—Normally-Closed

**HIFLUID**

## Dimensions

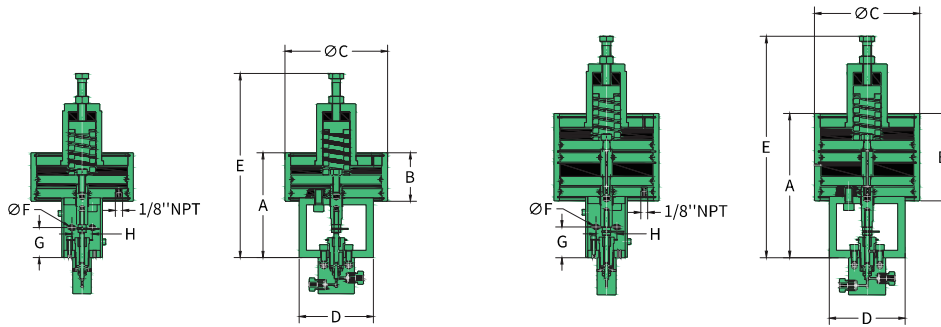

Actuator Type	Suffix	Piston Area in. <sup>2</sup> (mm <sup>2</sup> )	Dimensions in. (mm)							
			A	B	C	D	E*	F	G	H
Light Duty	4;6;9 - MNC	19.6 (12.645)	5.79 (147.3)	2.69 (68.3)	5.67 (144)	4.09 (104)	10.09 (256.3)	0.28 (7)	1.65 (42)	1.13 (28.8)
Heavy Duty	4;6;9 - HNC	39.2 (25.290)	7.78 (197.8)	4.72 (119.9)	5.67 (144)	4.09 (104)	12.59 (320)	0.28 (7)	1.65 (42)	1.13 (28.8)

\*E dimension is an approximation only.

## Technical Data

Pressure Rating	O.D. Size in.	Air Actuator			Air pressure required to open Valve at: System Pressure ksi (bar)										Max. Pressure psi (bar)	Flow Coefficient Cv*		
		Type	Suffix	Data	1-12 (68-827)	14 (965)	16 (1,103)	18 (1,241)	20 (1,379)	22 (1,517)	24 (1,655)	26 (1,793)	28 (1,930)	30 (2,068)				
30	1/4	Light Duty	-MNC	Air Pressure psi (bar)	45 (3.1)	55 (3.8)	55 (3.8)	55 (3.8)	55 (3.8)	65 (4.5)	65 (4.5)	65 (4.5)	65 (4.5)	75 (5.2)	30,000 (2,068)	0.12		
				Spring Pre-Compression in. (mm)	0.12 (3)	0.19 (4.8)	0.19 (4.8)	0.19 (4.8)	0.19 (4.8)	0.25 (6.4)	0.25 (6.4)	0.25 (6.4)	0.25 (6.4)	0.31 (7.9)				
				Stem Travel in. (mm)	0.19 (4.8)	0.19 (4.8)	0.19 (4.8)	0.19 (4.8)	0.19 (4.8)	0.19 (4.8)	0.19 (4.8)	0.19 (4.8)	0.19 (4.8)	0.19 (4.8)				
		Heavy Duty	-HNC	Air Pressure psi (bar)	25 (1.7)	30 (2.1)	30 (2.1)	30 (2.1)	30 (2.1)	35 (2.4)	35 (2.4)	35 (2.4)	35 (2.4)	40 (2.8)			30,000 (2,068)	0.12
				Spring Pre-Compression in. (mm)	0.12 (4.8)	0.19 (4.8)	0.19 (4.8)	0.19 (4.8)	0.19 (4.8)	0.25 (6.4)	0.25 (6.4)	0.25 (6.4)	0.25 (6.4)	0.31 (7.9)				
				Stem Travel in. (mm)	0.19 (4.8)	0.19 (4.8)	0.19 (4.8)	0.19 (4.8)	0.19 (4.8)	0.19 (4.8)	0.19 (4.8)	0.19 (4.8)	0.19 (4.8)	0.19 (4.8)				
	3/8 9/16	Light Duty	-MNC	Air Pressure psi (bar)	55 (3.8)	55 (3.8)	65 (4.5)	65 (4.5)	75 (5.2)	75 (5.2)	75 (5.2)	85 (5.9)	85 (5.9)	95 (6.6)	30,000 (2,068)	0.33		
				Spring Pre-Compression in. (mm)	0.19 (4.8)	0.19 (4.8)	0.25 (6.4)	0.25 (6.4)	0.31 (7.9)	0.31 (7.9)	0.31 (7.9)	0.38 (9.7)	0.38 (9.7)	0.44 (11.2)				
				Stem Travel in. (mm)	0.19 (4.8)	0.19 (4.8)	0.19 (4.8)	0.19 (4.8)	0.19 (4.8)	0.19 (4.8)	0.19 (4.8)	0.19 (4.8)	0.19 (4.8)	0.19 (4.8)				
		Heavy Duty	-HNC	Air Pressure psi (bar)	30 (2.1)	30 (2.1)	35 (2.4)	40 (2.8)	40 (2.8)	45 (3.1)	45 (3.1)	45 (3.1)	45 (3.1)	50 (3.5)			30,000 (2,068)	0.33
				Spring Pre-Compression in. (mm)	0.19 (4.8)	0.19 (4.8)	0.25 (6.4)	0.25 (6.4)	0.31 (7.9)	0.31 (7.9)	0.31 (7.9)	0.38 (9.7)	0.38 (9.7)	0.44 (11.2)				
				Stem Travel in. (mm)	0.19 (4.8)	0.19 (4.8)	0.19 (4.8)	0.19 (4.8)	0.19 (4.8)	0.19 (4.8)	0.19 (4.8)	0.19 (4.8)	0.19 (4.8)	0.19 (4.8)				

\* Cv values are for straight pattern valves, increase this value by 50% for angle pattern valves.

Cv values vary due to compression of actuator spring, and are adjusted based on system pressure. Values shown are for maximum to minimum stem travel position.

-  High Pressure
- Needle Valves
- Hand-Operated Actuator
- Normally-Open
- Normally-Closed
- Double-Acting
- Check Valves
- Relief Valves
- Filters
- Fittings
- Adapters and Couplings
- Tubing

# High Pressure—Actuator Needle Valves—Normally-Closed

## Technical Data

Pre-ssure Rating	O.D. Size in.	Air Actuator			Air pressure required to open Valve at: System Pressure ksi (bar)										Max. Pressure psi (bar)	Flow Coefficient Cv*		
		Type	Suffix	Data	1-15 (68-1,034)	20 (1,379)	25 (1,724)	30 (2,068)	35 (2,413)	40 (2,758)	45 (3,103)	50 (3,447)	55 (3,792)	60 (4,137)				
60	1/4 3/8	Light Duty	-MNC	Air Pressure psi (bar)	55 (3.8)	65 (4.5)	65 (4.5)	65 (4.5)	75 (5.2)	75 (5.2)	85 (5.9)	85 (5.9)	85 (5.9)	95 (6.6)	60,000 (4,137)	0.08		
				Spring Pre-Compression in. (mm)	0.12 (3)	0.19 (4.8)	0.19 (4.8)	0.19 (4.8)	0.25 (6.4)	0.25 (6.4)	0.31 (7.9)	0.31 (7.9)	0.31 (7.9)	0.37 (9.7)				
				Stem Travel in. (mm)	0.25 (6.4)	0.25 (6.4)	0.25 (6.4)	0.25 (6.4)	0.25 (6.4)	0.25 (6.4)	0.25 (6.4)	0.25 (6.4)	0.25 (6.4)	0.25 (6.4)				
		Heavy Duty	-HNC	Air Pressure psi (bar)	30 (2.1)	35 (2.4)	35 (2.4)	35 (2.4)	40 (2.8)	40 (2.8)	45 (3.1)	45 (3.1)	45 (3.1)	50 (3.5)			60,000 (4,137)	0.09
				Spring Pre-Compression in. (mm)	0.12 (4.8)	0.19 (4.8)	0.19 (4.8)	0.19 (4.8)	0.25 (6.4)	0.25 (6.4)	0.31 (7.9)	0.31 (7.9)	0.31 (7.9)	0.38 (9.7)				
				Stem Travel in. (mm)	0.25 (6.4)	0.25 (6.4)	0.25 (6.4)	0.25 (6.4)	0.25 (6.4)	0.25 (6.4)	0.25 (6.4)	0.25 (6.4)	0.25 (6.4)	0.25 (6.4)				
	9/16	Light Duty	-MNC	Air Pressure psi (bar)	55 (3.8)	65 (4.5)	65 (4.5)	75 (5.2)	75 (5.2)	85 (5.9)	95 (6.6)	95 (6.6)	95 (6.6)	95 (6.6)	60,000 (4,137)	1.04		
				Spring Pre-Compression in. (mm)	0.12 (3)	0.19 (4.8)	0.19 (4.8)	0.25 (6.4)	0.25 (6.4)	0.31 (7.9)	0.38 (9.7)	0.38 (9.7)	0.44 (11.2)	0.50 (12.7)				
				Stem Travel in. (mm)	0.25 (6.4)	0.25 (6.4)	0.25 (6.4)	0.25 (6.4)	0.25 (6.4)	0.25 (6.4)	0.25 (6.4)	0.25 (6.4)	0.19 (4.8)	0.12 (3)				
		Heavy Duty	-HNC	Air Pressure psi (bar)	30 (2.1)	35 (2.4)	35 (2.4)	40 (2.8)	40 (2.8)	45 (3.1)	50 (3.5)	50 (3.5)	50 (3.5)	50 (3.5)			60,000 (4,137)	
				Spring Pre-Compression in. (mm)	0.12 (3)	0.19 (4.8)	0.19 (4.8)	0.25 (6.4)	0.25 (6.4)	0.31 (7.9)	0.38 (9.7)	0.38 (9.7)	0.44 (11.2)	0.50 (12.7)				
				Stem Travel in. (mm)	0.25 (6.4)	0.25 (6.4)	0.25 (6.4)	0.25 (6.4)	0.25 (6.4)	0.25 (6.4)	0.25 (6.4)	0.25 (6.4)	0.19 (4.8)	0.12 (3)				



- Needle Valves
- Hand-Operated Actuator
- Normally-Open
- Normally-Closed**
- Double-Acting
- Check Valves
- Relief Valves
- Filters
- Fittings
- Adapters and Couplings
- Tubing

\* Cv values are for straight pattern valves, increase this value by 50% for angle pattern valves.  
 Cv values vary due to compression of actuator spring, and are adjusted based on system pressure. Values shown are for maximum to minimum stem travel position.

Pressure to 30,000psi (2,068bar), 43,000psi (2,965bar), 60,000psi (4,137bar)

# High Pressure—Actuator Needle Valves—Double-Acting

**HIFLUID**

## Dimensions

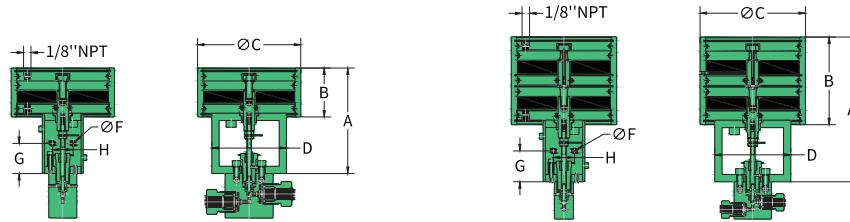

Actuator Type	Suffix	Piston Area in. <sup>2</sup> (mm <sup>2</sup> )	Dimensions in. (mm)						
			A	B	C	D	F	G	H
Light Duty	4;6;9-MNO	19.6 (12.645)	5.79 (147.3)	2.69 (68.3)	5.67 (144)	4.09 (104)	0.28 (7)	1.65 (42)	1.13 (28.8)
Heavy Duty	4;6;9-HNO	39.2 (25.290)	7.78 (197.8)	4.72 (119.9)	5.67 (144)	4.09 (104)	0.28 (7)	1.65 (42)	1.13 (28.8)

## Technical Data

Pre- pressure Rating	O.D. Size in.	Air Actuator		Air pressure required to close Valve at: System Pressure ksi (bar)										Max. Pressure psi (bar)	Stem Travel in.(mm)	Flow Coefficient Cv*
		Type	Suffix	1-12 (68-827)	14 (965)	16 (1,103)	18 (1,241)	20 (1,379)	22 (1,517)	24 (1,655)	26 (1,793)	28 (1,930)	30 (2,068)			
30	1/4	Light Duty	-MDA	25 (1.7)	25 (1.7)	30 (2.1)	35 (2.4)	35 (2.4)	40 (2.8)	45 (3.1)	50 (3.5)	50 (3.5)	55 (3.8)	30,000 (2,068)	0.19 (4.8)	0.12
		Heavy Duty	-HDA	15 (1)	15 (1)	15 (1)	20 (1.4)	20 (1.4)	20 (1.4)	25 (1.7)	25 (1.7)	25 (1.7)	30 (2.1)			
	3/8 9/16	Light Duty	-MDA	30 (2.1)	35 (2.4)	40 (2.8)	45 (3.1)	50 (3.5)	55 (3.8)	60 (4.2)	65 (4.5)	70 (4.9)	72 (5)	30,000 (2,068)	0.19 (4.8)	0.23
		Heavy Duty	-HDA	15 (1)	20 (1.4)	20 (1.4)	25 (1.7)	25 (1.7)	30 (2.1)	30 (2.1)	35 (2.4)	35 (2.4)	40 (2.8)			0.33

Pre- pressure Rating	O.D. Size in.	Air Actuator		Air pressure required to close Valve at: System Pressure ksi (bar)										Max. Pressure psi (bar)	Stem Travel in.(mm)	Flow Coefficient Cv*
		Type	Suffix	1-15 (68-1,034)	20 (1,379)	25 (1,724)	30 (2,068)	35 (2,413)	40 (2,758)	45 (3,103)	50 (3,447)	55 (3,792)	60 (4,137)			
60	1/4 3/8	Light Duty	-MDA	30 (2.1)	30 (2.1)	30 (2.1)	35 (2.4)	45 (3.1)	50 (3.5)	55 (3.8)	60 (4.2)	70 (4.9)	75 (5.2)	60,000 (4,137)	0.25 (6.4)	0.08
		Heavy Duty	-HDA	15 (1)	15 (1)	15 (1)	20 (1.4)	25 (1.7)	25 (1.7)	30 (2.1)	30 (2.1)	35 (2.4)	40 (2.8)			0.09
	9/16	Light Duty	-MDA	35 (2.4)	35 (2.4)	40 (2.8)	50 (3.5)	55 (3.8)	65 (4.5)	70 (4.9)	75 (5.2)	85 (5.9)	90 (6.2)	60,000 (4,137)	0.25 (6.4)	0.14
		Heavy Duty	-HDA	20 (1.4)	20 (1.4)	20 (1.4)	25 (1.7)	30 (2.1)	35 (2.4)	35 (2.5)	40 (2.8)	45 (3.1)	45 (3.1)			

\* Cv values are for straight pattern valves, increase this value by 50% for angle pattern valves.

Cv values vary due to compression of actuator spring, and are adjusted based on system pressure. Values shown are for maximum to minimum stem travel position.

-  High Pressure
- Needle Valves
- Hand-Operated Actuator
- Normally-Open
- Normally-Closed
- Double-Acting
- Check Valves
- Relief Valves
- Filters
- Fittings
- Adapters and Couplings
- Tubing

# High Pressure—Check Valves



## O-Ring Check Valves

An O-ring check valve uses an elastomer O-ring to achieve one-way flow control. The pre-compressed elastic seal prevents reverse flow, delivering tight shutoff and sensitive opening—particularly suitable for high-pressure gas and liquid control systems.

The standard O-ring check valves seal with FKM, operate from -20°C to 200°C (-4°F to 392°F), The opening pressure of the O-ring check valves is approx. 20psi (1.38bar),  $\pm 30\%$ .

## Ball Check Valves

A ball check valve controls one-way flow using a spherical element. When differential pressure drops below the set opening pressure, the valve automatically closes to prevent backflow—ideal where sealing requirements are relatively lower, but backflow must be avoided.

HiFluid ball check valves are suitable for service up to 349°C (660°F), The opening pressure of the ball check valves is approx. 20psi (1.38bar),  $\pm 30\%$ .



Needle Valves

### Check Valves

O-Ring Check  
Ball Check

Relief Valves

Filters

Fittings

Adapters and  
Couplings

Tubing

Pressure to 30,000psi (2,068bar), 43,000psi (2,965bar), 60,000psi (4,137bar)

# High Pressure—O-Ring Check Valves

## Selection Example

60		V61		H6		-TO	
Pressure Rating		Component Type		Connection Size		Options	
43 (only M16H)	43,000psi	V61	O-Ring Check Valves	H4	1/4"	BO	Buna-N O-ring -29°C to 121°C (-20°F to 250°F)
60	60,000psi			H6	3/8"	EO	EPDM O-ring -40°C to 130°C (-40°F to 266°F)
				H9	9/16"	KO	FFKM O-ring -18°C to 260°C (0°F to 500°F)
				M16H	1" (only 43 series)	LTTO	PTFE O-ring with Low Temp. Spring -252°C (-423°F)
						TO	PTFE O-ring -73°C to 204°C (-100°F to 400°F)

-  High Pressure
- Needle Valves
- Check Valves
- O-Ring Check**
- Ball Check
- Relief Valves
- Filters
- Fittings
- Adapters and Couplings
- Tubing

## Dimensions

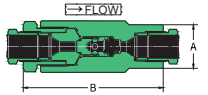
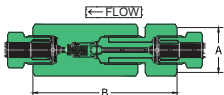
Valve Pattern	Type	Connection Type	Max. Pressure psi (bar)	Orifice in. (mm)	Rated (Cv)	Dimensions in. (mm)	
						A(HEX.)	B
<b>O-Ring Check Valves</b>							
	43V61M16	M16HF	43,000 (2,965)	0.438 (11.1)	4.3	2.00 (50.8)	6.433 (163.4)
	60V61H4	H4F	60,000 (4,137)	0.094 (2.3)	0.15	1.18 (30)	3.40 (86.4)
	60V61H6	H6F	60,000 (4,137)	0.125 (3.2)	0.28	1.18 (30)	3.81 (96.8)
	60V61H9	H9F	60,000 (4,137)	0.188 (4.8)	0.63	1.65 (42)	4.61 (117.1)

Pressure to 30,000psi (2,068bar), 43,000psi (2,965bar), 60,000psi (4,137bar)

# High Pressure—Ball Check Valves

## Selection Example

60		V62		H9		-LTS	
Pressure Rating		Component Type		Connection Size		Options	
43 (only M16H)	43,000psi	V62	Ball Check Valve	H4	1/4"	LTS	Low Temperature Spring -252°C (-423°F)
60	60,000psi			H6	3/8"		
				H9	9/16"		
				M16H	1" (only 43 series)		



Needle Valves

Check Valves

O-Ring Check

Ball Check

Relief Valves

Filters

Fittings

Adapters and Couplings

Tubing

## Dimensions

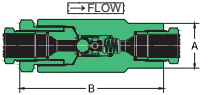
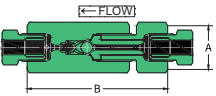
Valve Pattern	Type	Connection Type	Max. Pressure psi (bar)	Orifice in. (mm)	Rated (Cv)	Dimensions in. (mm)	
						A (HEX.)	B
<b>Ball Check Valves</b>							
	43V62M16	M16HF	43,000 (2,965)	0.438 (11.1)	4.3	2.00 (50.8)	6.433 (163.4)
	60V62H4	H4F	60,000 (4,137)	0.094 (2.3)	0.15	1.18 (30)	3.40 (86.4)
	60V62H6	H6F	60,000 (4,137)	0.125 (3.2)	0.28	1.18 (30)	3.81 (96.8)
	60V62H9	H9F	60,000 (4,137)	0.188 (4.8)	0.63	1.65 (42)	4.61 (117.1)

# High Pressure—Relief Valves



## Relief Valves

A relief valve is an adjustable pressure-safety device used in hydraulic or pneumatic systems to prevent overpressure and ensure safe, stable operation. When system pressure reaches the setpoint, the valve opens to discharge excess pressure, avoiding equipment damage and safety incidents.

HiFluid relief valves provide a 3/4" NPT outlet and modular construction; the seat, collar, and gland are individually replaceable for convenient maintenance and extended service life.



- Needle Valves
- Check Valves
- Relief Valves**
- Filters
- Fittings
- Adapters and Couplings
- Tubing

### Selection Example

60		V7		H6	
Pressure Rating		Component Type		Connection Size	
30	30,000psi	V7	Relief Valve	H6	3/8"
43 (only H9)	43,000psi			H9	9/16" (only 43 series)
60	60,000psi				

### Dimensions

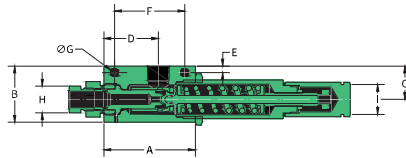

Type	Max. Pressure psi (bar)	Pressure range min/max psi(bar)	Orifice in. (mm)	Inlet Con- nection Size	Outlet Con- nection Size	Dimensions in. (mm)									Block Thick- ness
						A	B	C	D	E	F	G	H (Hex.)	I (Hex.)	
30V7H6	30,000 (2,068)	15,000/30,000 (1,034/2,068)	0.125 (3.18)	H6F	NPT3/4"	3.25 (82.5)	2 (50.8)	1.19 (30.2)	1.94 (49.3)	0.25 (6.35)	2.5 (63.5)	0.30 (7.5)	0.83 (21)	1.06 (27)	1.5 (38)
43V7H9	43,000 (2,965)	30,000/43,000 (2,068/2,965)	0.093 (2.36)	H9F	NPT3/4"	3.25 (82.5)	2 (50.8)	1.19 (30.2)	1.94 (49.3)	0.25 (6.35)	2.5 (63.5)	0.30 (7.5)	1.18 (30)	1.06 (27)	1.5 (38)
60V7H6	60,000 (4,137)	30,000/60,000 (2,068/4,137)	0.078 (1.98)	H6F	NPT3/4"	3.25 (82.5)	2 (50.8)	1.19 (30.2)	1.94 (49.3)	0.25 (6.35)	2.5 (63.5)	0.30 (7.5)	0.83 (21)	1.06 (27)	1.5 (38)

# High Pressure—Filters



## Dual-Disc Line Filters

Dual-Disc Line Filters capture solid contaminants in the fluid to protect downstream equipment and ensure safe operation. The filter adopts a dual-stage, dual-element design. Standard grades include 5/8  $\mu\text{m}$ , 8/30  $\mu\text{m}$ , and 30/56  $\mu\text{m}$  for flexible selection across operating conditions.

Operating temperature range:  $-253^{\circ}\text{C}$  to  $349^{\circ}\text{C}$  ( $-423^{\circ}\text{F}$  to  $660^{\circ}\text{F}$ ), suitable for filtration under both extreme cryogenic and high-temperature conditions. All filters are supplied with glands and collars for reliable connections and convenient maintenance.



## Cup-Type Line Filters

Cup-Type Line Filters capture solid impurities to protect downstream systems. The cup element provides a larger filtration area. Standard ratings: 5 $\mu\text{m}$ , 30 $\mu\text{m}$ , 56 $\mu\text{m}$ .

Operating temperature range:  $-253^{\circ}\text{C}$  to  $349^{\circ}\text{C}$  ( $-423^{\circ}\text{F}$  to  $660^{\circ}\text{F}$ ), suitable for filtration under both extreme cryogenic and high-temperature conditions. All filters are supplied with glands and collars for reliable connections and convenient maintenance.



## Angle Filters

Angle Filters capture solid impurities to protect downstream equipment. Compared with Cup-Type Line Filters, the angle design allows element replacement without dismantling piping, making maintenance more convenient. Standard ratings: 5 $\mu\text{m}$ , 30 $\mu\text{m}$ , 56 $\mu\text{m}$ , which can be flexibly selected according to different operating requirements.

Operating temperature range:  $-253^{\circ}\text{C}$  to  $349^{\circ}\text{C}$  ( $-423^{\circ}\text{F}$  to  $660^{\circ}\text{F}$ ), suitable for filtration under both extreme cryogenic and high-temperature conditions. All angle filters are supplied with glands and collars to ensure reliable connections and ease of maintenance.



- Needle Valves
- Check Valves
- Relief Valves
- Filters**
- Dual-Disc Line
- Cup-Type Line
- Angle
- Fittings
- Adapters and Couplings
- Tubing

Pressure to 30,000psi (2,068bar), 43,000psi (2,965bar), 60,000psi (4,137bar)

# High Pressure—Dual-Disc Line Filters

**HIFLUID**

## Selection Example

60		F61		H9		-5/8	
Pressure Rating		Component Type		Connection Size		Micron Size (µm)	
60	60,000psi	F61	Dual-Disc Line Filters	H4	1/4"	5/8	
				H6	3/8"	8/30	
				H9	9/16"	30/56	



## Dimensions

Filter Pattern	Type	Max. Pressure psi (bar)	Orifice in. (mm)	Micron Size (µm)	Connec- tion Type	Filter Element Area in <sup>2</sup> (mm <sup>2</sup> )	Dimensions in. (mm)		
							A	B	C (HEX.)
<b>Dual-Disc Line Filters</b>									
	60F61H4-5/8	60,000 (4,137)	0.094(2.3)	5/8	H4F	0.07 (50)	2.99 (76)	4.8 (121.9)	1.18 (30)
	60F61H4-8/30			8/30					
	60F61H4-30/56			30/56					
	60F61H6-5/8	60,000 (4,137)	0.125(3.2)	5/8	H6F	0.07 (50)	2.99 (76)	5.29 (134.4)	1.18 (30)
	60F61H6-8/30			8/30					
	60F61H6-30/56			30/56					
	60F61H9-5/8	60,000 (4,137)	0.188(4.8)	5/8	H9F	0.15 (95)	3.39 (86.1)	5.75 (146)	1.42 (36)
	60F61H9-8/30			8/30					
	60F61H9-30/56			30/56					

- Needle Valves
- Check Valves
- Relief Valves
- Filters
  - Dual-Disc Line
  - Cup-Type Line
  - Angle
- Fittings
- Adapters and Couplings
- Tubing

- Note: 1. All fluids entering the high-pressure system should be thoroughly cleaned.  
 2. Filters are designed to remove small process particles.  
 3. The differential pressure across the filter element should not exceed 1,000 psi.

# High Pressure—Cup-Type Line Filters

## Selection Example

60		F62		H4		-5
Pressure Rating		Component Type		Connection Size		Micron Size (µm)
60	60,000psi	F62	Cup-Type Inline Filter	H4	1/4"	5
				H6	3/8"	30
				H9	9/16"	56



## Dimensions

Filter Pattern	Type	Max. Pressure psi (bar)	Orifice in. (mm)	Micron Size (um)	Connection Type	Filter Element Area in <sup>2</sup> (mm <sup>2</sup> )	Dimensions in. (mm)		
							A	B	C (HEX.)
<b>Cup-Type Line Filters</b>									
	60F62H4-5	60,000 (4,137)	0.094(2.3)	5	H4F	0.82 (530)	3.39 (86.1)	4.25 (108)	1.42 (36)
	60F62H4-30			30					
	60F62H4-56			56					
	60F62H6-5	60,000 (4,137)	0.125(3.2)	5	H6F	0.82 (530)	3.39 (86.1)	4.44 (112.8)	1.42 (36)
	60F62H6-30			30					
	60F62H6-56			56					
	60F62H9-5	60,000 (4,137)	0.188(4.8)	5	H9F	0.82 (530)	4.06 (103.1)	5.28 (134.1)	1.65 (42)
	60F62H9-30			30					
	60F62H9-56			56					

- Needle Valves
- Check Valves
- Relief Valves
- Filters
  - Dual-Disc Line
  - Cup-Type Line**
  - Angle
- Fittings
- Adapters and Couplings
- Tubing

- Note: 1. All fluids entering the high-pressure system should be thoroughly cleaned.  
 2. Filters are designed to remove small process particles.  
 3. The differential pressure across the filter element should not exceed 1,000 psi.

# High Pressure—Angle Filters

## Selection Example

60		F63		H4		-5	
Pressure Rating		Component Type		Connection Size		Micron Size (µm)	
60	60,000psi	F63	Angle Filter	H4	1/4"	5	
				H6	3/8"	30	
				H9	9/16"	56	

## Dimensions

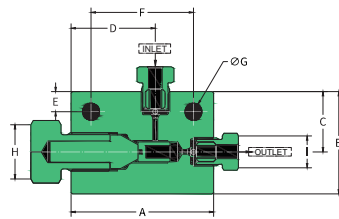

Type	Max. Pressure psi (bar)	Orifice in. (mm)	Conne- ction Type	Micron Size (µm)	Filter Element Area in <sup>2</sup> (mm <sup>2</sup> )	Dimensions in. (mm)										Block Thick- ness
						A	B	C	D	E	F	G	H (HEX.)	I (HEX.)		
<b>Angle Filters</b>																
60F63H4-5	60,000 (4,137)	0.094 (2.3)	H4F	5	0.82 (530)	2.80 (71)	2.01 (51)	1.18 (30)	1.65 (42)	0.39 (10)	2.01 (51)	0.34 (8.5)	1.06 (27)	0.63 (16)	1.02 (26)	
60F63H4-30				30												
60F63H4-56				56												
60F63H6-5	60,000 (4,137)	0.125 (3.2)	H6F	5	0.82 (530)	3.11 (79)	2.01 (51)	1.18 (30)	1.65 (42)	0.39 (10)	2.32 (59)	0.34 (8.5)	1.06 (27)	0.83 (21)	1.02 (26)	
60F63H6-30				30												
60F63H6-56				56												
60F63H9-5	60,000 (4,137)	0.188 (4.8)	H9F	5	0.82 (530)	3.23 (82)	2.64 (67)	1.32 (33.5)	1.65 (42)	0.39 (10)	2.44 (62)	0.34 (8.5)	1.06 (27)	1.18 (30)	1.54 (39)	
60F63H9-30				30												
60F63H9-56				56												

- Note: 1. All fluids entering the high-pressure system should be thoroughly cleaned.  
 2. Filters are designed to remove small process particles.  
 3. The differential pressure across the filter element should not exceed 1,000 psi.

-  High Pressure
- Needle Valves
- Check Valves
- Relief Valves
- Filters**
  - Dual-Disc Line
  - Cup-Type Line
  - Angle**
- Fittings
- Adapters and Couplings
- Tubing

# High Pressure—Fittings



## Accessories

All high pressure fittings are supplied with glands and collars to ensure sealing integrity and connection stability during field installation. Users may also purchase glands and collars separately as needed for more flexible system configuration.

## Straight Coupling, Elbow, Tee, Cross

HiFluid supplies a full range of straight coupling, elbow, tee, and cross fittings for multi-directional connections in high-pressure systems. All interfaces adopt the high-pressure cone-and-thread design to ensure reliable sealing and stable connections under high-pressure conditions.



## Anti-Vibration Collet Gland Assemblies

HiFluid anti-vibration collet gland assemblies are designed for piping systems subject to severe vibration or impact loads. They effectively buffer dynamic disturbances at the connection points, improving system stability and operational reliability.



- Needle Valves
- Check Valves
- Relief Valves
- Filters
- Fittings**
- Accessories
- Straight Coupling
- Elbow, Tee, Cross
- Anti-Vibration
- Collet Gland
- Assemblies
- Adapters and
- Couplings
- Tubing

# High Pressure—Accessories

## Selection Example

60		F71		H4	
Pressure Rating		Component Type		Connection Size	
43 (only M16H)	43,000psi	F71	Gland	H4	1/4"
60	60,000psi	F72	Collar	H6	3/8"
		F73	Plug	H9	9/16"
		F74	Tubing Cap	M16H	1" (only 43 series)



Needle Valves

Check Valves

Relief Valves

Filters

Fittings

Accessories

Straight Coupling

Elbow, Tee, Cross

Anti-Vibration

Collet Gland





Assemblies

Adapters and

Couplings

Tubing

## Dimensions

O.D.Size in. (mm)	Gland	Collar	Plug	Tubing Cap
				
1 (25.4)	43F71M16	43F72M16	43F73M16	43F74M16
1/4 (6.35)	60F71H4	60F72H4	60F73H4	60F74H4
3/8 (9.53)	60F71H6	60F72H6	60F73H6	60F74H6
9/16 (14.29)	60F71H9	60F72H9	60F73H9	60F74H9

Pressure to 30,000psi (2,068bar), 43,000psi (2,965bar), 60,000psi (4,137bar)

# High Pressure—Straight Coupling, Elbow, Tee, Cross

**HIFLUID**

## Selection Example

60		F2		H4	
Pressure Rating		Body Pattern		Connection Size	
43 (only M16H)	43,000psi	F1	Straight Coupling	H4	1/4"
60	60,000psi	F2	Angle	H6	3/8"
		F3	Tee	H9	9/16"
		F4	Cross	M16H	1" (only 43 series)



Needle Valves

Check Valves

Relief Valves

Filters

**Fittings**

Accessories

**Straight Coupling**

**Elbow, Tee, Cross**

Anti-Vibration

Collet Gland

Assemblies

Adapters and

Couplings

Tubing

# High Pressure—Straight Coupling, Elbow, Tee, Cross

## Dimensions

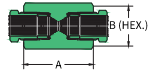
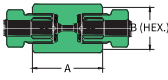
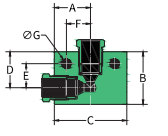
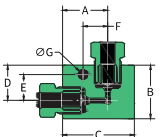
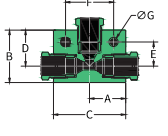
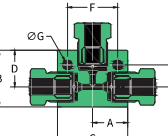
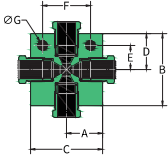
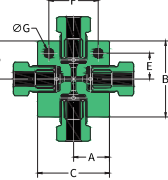
Body Pattern	Type	Connection Type	O.D. Size in.	Orifice in. (mm)	Dimensions in. (mm)							Block Thickness
					A	B	C	D	E	F	G	
<b>Straight Coupling</b>												
	43F1M16	M16HF	1	0.438 (11.1)	3.50 (89)	2.00 (50.8)						
	60F1H4	H4F	1/4	0.094 (2.3)	1.38 (35)	1.06 (27)						
	60F1H6	H6F	3/8	0.125 (3.2)	1.77 (45)	1.06 (27)						
	60F1H9	H9F	9/16	0.188 (4.8)	2.19 (55.6)	1.44 (38)						
<b>Elbow</b>												
	43F2M16	M16HF	1	0.438 (11.1)	2.07 (52.5)	3.00 (76.2)	4.13 (105)	2.06 (52.3)	1.38 (35)	1.38 (35)	0.53 (13.5)	1.77 (45)
	60F2H4	H4F	1/4	0.438 (11.1)	0.89 (22.6)	1.02 (25.9)	1.54 (39)	0.63 (16)	0.46 (11.7)	0.65 (16.5)	0.22 (5.6)	1.02 (26)
	60F2H6	H6F	3/8	0.125 (3.2)	1.26 (32)	1.50 (38.1)	2.01 (51)	0.98 (24.9)	0.72 (18.3)	0.69 (17.5)	0.26 (6.6)	1.02 (26)
	60F2H9	H9F	9/16	0.188 (4.8)	1.89 (48)	1.89 (48)	2.64 (67)	1.10 (28)	0.83 (21.1)	0.94 (23.9)	0.33 (8.4)	1.54 (39)
<b>Tee</b>												
	43F3M16	M16HF	1	0.438 (11.1)	2.07 (52.5)	3.00 (76.2)	4.13 (105)	2.06 (52.3)	1.38 (35)	2.76 (70)	0.53 (13.5)	1.77 (45)
	60F3H4	H4F	1/4	0.094 (2.3)	1.00 (25.4)	1.26 (32)	2.01 (51)	0.89 (22.6)	0.46 (11.7)	1.30 (33)	0.22 (5.6)	1.02 (26)
	60F3H6	H6F	3/8	0.125 (3.2)	1.00 (25.4)	1.57 (39.9)	2.01 (51)	1.06 (26.9)	0.72 (18.3)	1.38 (35)	0.26 (6.6)	1.02 (26)
	60F3H9	H9F	9/16	0.188 (4.8)	1.32 (33.5)	2.13 (54.1)	2.64 (67)	1.38 (35)	0.83 (21.1)	1.89 (48)	1.89 (48)	1.54 (39)
<b>Cross</b>												
	43F4M16	M16HF	1	0.438 (11.1)	2.07 (52.5)	4.13 (105)	4.13 (105)	2.07 (52.5)	1.38 (35.2)	2.75 (70)	0.53 (13.5)	1.77 (45)
	60F4H4	H4F	1/4	0.094 (2.3)	1.00 (25.4)	1.26 (32)	2.01 (51)	0.63 (16)	0.46 (11.7)	1.30 (33)	0.22 (5.6)	1.02 (26)
	60F4H6	H6F	3/8	0.125 (3.2)	1.00 (25.4)	2.13 (54.1)	2.01 (51)	1.06 (27)	0.72 (18.3)	1.38 (35)	0.26 (6.6)	1.02 (26)
	60F4H9	H9F	9/16	0.188 (4.8)	1.32 (33.5)	2.76 (70.1)	2.64 (67)	1.38 (35)	0.83 (21.1)	1.89 (48)	0.33 (8.4)	1.54 (39)

**High Pressure**

- Needle Valves
- Check Valves
- Relief Valves
- Filters
- Fittings
  - Accessories
  - Straight Coupling
  - Elbow, Tee, Cross
  - Anti-Vibration
  - Collet Gland Assemblies
- Adapters and Couplings
- Tubing

Pressure to 30,000psi (2,068bar), 43,000psi (2,965bar), 60,000psi (4,137bar)

# High Pressure—Anti-Vibration Collet Gland Assemblies

**HIFLUID**

## Selection Example

60		F75		H4		-AVA
Pressure Rating		Component Type		Connection Size		Code
43 (only M16H)	43,000psi	F71	Gland	H4	1/4"	AVA-Anti-Vibration Collet Gland Assemblies
60	60,000psi	F72	Collar	H6	3/8"	
		F75	Ferrule	H9	9/16"	
		F8	Vibration-Resistant Coupling	M16H	1" (only 43 series)	



Needle Valves

Check Valves

Relief Valves

Filters

Fittings

Accessories

Straight Coupling

Elbow, Tee, Cross

Anti-Vibration Collet Gland Assemblies

Adaptors and Couplings

Tubing

## Dimensions

Gland Pattern	Type	Component	O.D. Size in.	Dimensions in. (mm)		
				A	B (HEX.)	
<b>Anti-Vibration Collet Gland Assemblies</b>						
	43F8M16	Complete Assembly	1	2.44 (61.9)	1.50 (38)	
	43F72M16-AVA	Collet Body				
	43F75M16-AVA	Slotted Collet				
	43F71M16-AVA	Gland Nut				
	60F8H4	Complete Assembly	1/4	0.83 (21)	0.63 (16)	
	60F72H4-AVA	Collet Body				
	60F75H4-AVA	Slotted Collet				
	60F71H4-AVA	Gland Nut				
		60F8H6	Complete Assembly	3/8	1.16 (29.5)	0.83 (21)
		60F72H6-AVA	Collet Body			
		60F75H6-AVA	Slotted Collet			
		60F71H6-AVA	Gland Nut			
		60F8H9	Complete Assembly	9/16	1.50 (38)	1.18 (30)
		60F72H9-AVA	Collet Body			
		60F75H9-AVA	Slotted Collet			
		60F71H9-AVA	Gland Nut			

# High Pressure—Adapters and Couplings



## Adapters (Male to Female)

HiFluid male to female adapters convert between different thread types or sizes, connecting a female thread to a male thread. Both ends may use different thread forms and sizes to meet installation needs under complex conditions.

The adapter's pressure rating is limited by the lower rating of the two ends. Naming rule: list the female size first, then the male size.

## Couplings (Female to Female)

HiFluid female to female couplings convert between different thread types or sizes, connecting two male threads. Both ends may use different thread forms and sizes to meet installation needs under complex conditions.

The pressure rating is limited by the lower rating of the two ends. Naming rule: under the same pressure rating, list the smaller size first; if ratings differ, list the lower-pressure first.



## Adapters (Male to Male)

HiFluid male to male adapters convert between different thread types or sizes, connecting two female threads. Both ends may use different thread forms and sizes to meet installation needs under complex conditions.

The pressure rating is limited by the lower rating of the two ends. Naming rule: under the same pressure rating, list the smaller size first; if ratings differ, list the lower-pressure first.



High Pressure

Needle Valves

Check Valves

Relief Valves

Filters

Fittings

**Adapters and Couplings**

Adapters (Male to Female)

Couplings (Female to Female)

Adapters (Male to Male)

Tubing

Pressure to 30,000psi (2,068bar), 43,000psi (2,965bar), 60,000psi (4,137bar)

# High Pressure—Adapters (Male to Female)

**HIFLUID**

## Selection Example

60		F51		H6		H4	
Pressure Rating		Component Type		Female Size		Male Size	
43 (only M16H)	43,000psi	F51	Adapters (Male to Female)	H4	1/4"	H4, U4-1/4"	
60	60,000psi			H6	3/8"	U5-5/16"	
				H9	9/16"	H6, U6-3/8"	
				M16H	1" (only 43 series)	H9, U9-9/16"	
						M16H-1" (43 series)	

-  High Pressure
- Needle Valves
- Check Valves
- Relief Valves
- Filters
- Fittings
- Adapters and Couplings
  - Adapters (Male to Female)
  - Couplings (Female to Female)
  - Adapters (Male to Male)
- Tubing

## Model Data

Male			Female			
O.D. Size in.	Connection Type	Max. Pressure psi (bar)*	43,000psi (2,965bar)	60,000psi (4,137bar)		
			1" M16H	1/4" H4	3/8" H6	9/16" H9
High-Pressure			High-Pressure			
1	M16H	43,000 (2,965)	43F51M16H	43F51H4M16H	43F51H6M16H	43F51H9M16H
1/4	H4	60,000 (4,137)	43F51M16HH4	60F51H4	60F51H6H4	60F51H9H4
3/8	H6	60,000 (4,137)	43F51M16HH6	60F51H4H6	60F51H6	60F51H9H6
9/16	H9	60,000 (4,137)	43F51M16HH9	60F51H4H9	60F51H6H9	60F51H9
Ultra-High Pressure			Ultra-High Pressure			
1/4	U4	100,000 (6,896)	43F51M16HU4	60F51H4U4	60F51H6U4	60F51H9U4
3/8	U6	100,000 (6,896)	43F51M16HU6	60F51H4U6	60F51H6U6	60F51H9U6
9/16	U9	100,000 (6,896)	43F51M16HU9	60F51H4U9	60F51H6U9	60F51H9U9
5/16	U5	150,000 (10,344)	43F51M16HU5	60F51H4U5	60F51H6U5	60F51H9U5

Male			Female			
O.D. Size in.	Connection Type	Max. Pressure psi (bar)*	100,000psi (6,896bar)			150,000psi (10,344bar)
			1/4" U4	3/8" U6	9/16" U9	5/16" U5
High-Pressure			Ultra-High Pressure			
1	M16H	43,000 (2,965)	43F51U4M16H	43F51U6M16H	43F51U9M16H	43F51U5M16H
1/4	H4	60,000 (4,137)	43F51U4H4	60F51U6H4	60F51U9H4	60F51U5H4
3/8	H6	60,000 (4,137)	43F51U4H6	60F51U6H6	60F51U9H6	60F51U5H6
9/16	H9	60,000 (4,137)	43F51U4H9	60F51U6H9	60F51U9H9	60F51U5H9

\* The pressure rating of any adapter is the value of the lowest rated connection in the fitting.

Pressure to 30,000psi (2,068bar), 43,000psi (2,965bar), 60,000psi (4,137bar)

# High Pressure—Couplings (Female to Female)

**HIFLUID**

## Selection Example

60		F52		H4		H6	
Pressure Rating		Component Type		Female Size		Female Size	
43 (only M16H)	43,000psi	F52	Couplings (Female to Female)	H4	1/4"	H4, U4-1/4"	
60	60,000psi			H6	3/8"	U5-5/16"	
				H9	9/16"	H6, U6-3/8"	
				M16H	1" (only 43 series)	H9, U9-9/16"	
						M16H-1" (43 series)	



- Needle Valves
- Check Valves
- Relief Valves
- Filters
- Fittings

## Model Data

O.D. Size in.	Female		Female			
	Connection Type	Max. Pressure psi (bar)*	43,000psi (2,965bar)	60,000psi (4,137bar)		
			1" M16H	1/4" H4	3/8" H6	9/16" H9
			High-Pressure			
<b>High-Pressure</b>						
1	M16H	43,000 (2,965)		43F52M16HH4	43F52M16HH6	43F52M16HH9
1/4	H4	60,000 (4,137)	43F52M16HH4		60F52H4H6	60F52H4H9
3/8	H6	60,000 (4,137)	43F52M16HH6			60F52H6H9
9/16	H9	60,000 (4,137)	43F52M16HH9			
<b>Ultra-High Pressure</b>						
1/4	U4	100,000 (6,896)	43F52M16HU4	60F52H4U4	60F52H6U4	60F52H9U4
3/8	U6	100,000 (6,896)	43F52M16HU6	60F52H4U6	60F52H6U6	60F52H9U6
9/16	U9	100,000 (6,896)	43F52M16HU9	60F52H4U9	60F52H6U9	60F52H9U9
5/16	U5	150,000 (10,344)	43F52M16HU5	60F52H4U5	60F52H6U5	60F52H9U5

- Adapters and Couplings
- Adapters (Male to Female)
- Couplings (Female to Female)
- Adapters (Male to Male)
- Tubing

\* The pressure rating of any adapter is the value of the lowest rated connection in the fitting.

Pressure to 30,000psi (2,068bar), 43,000psi (2,965bar), 60,000psi (4,137bar)

# High Pressure—Adapters (Male to Male)

## Selection Example

60		F53		H4		H6	
Pressure Rating		Component Type		Male Size		Male Size	
43 (only M16H)	43,000psi	F53	Adapters (Male to Male)	H4	1/4"	H4, U4-1/4"	
60	60,000psi			H6	3/8"	U5-5/16"	
				H9	9/16"	H6, U6-3/8"	
				M16H	1" (only 43 series)	H9, U9-9/16"	
						M16H-1" (43 series)	

-  High Pressure
- Needle Valves
- Check Valves
- Relief Valves
- Filters
- Fittings
- Adapters and Couplings
  - Adapters (Male to Female)
  - Couplings (Female to Female)
  - Adapters (Male to Male)
- Tubing

## Model Data

O.D. Size in.	Male		Male			
	Connection Type	Max. Pressure psi (bar)*	43,000psi (2,965bar)	60,000psi (4,137bar)		
			1" M16H	1/4" H4	3/8" H6	9/16" H9
			High-Pressure			
High-Pressure						
1	M16H	43,000 (2,965)	43F53M16H	43F53M16HH4	43F53M16HH6	43F53M16HH9
1/4	H4	60,000 (4,137)	43F53M16HH4	60F53H4	60F53H4H6	60F53H4H9
3/8	H6	60,000 (4,137)	43F53M16HH6		60F53H6	60F53H6H9
9/16	H9	60,000 (4,137)	43F53M16HH9			60F53H9
Ultra-High Pressure						
1/4	U4	100,000 (6,896)	43F53M16HU4	60F53H4U4	60F52H6U4	60F53H9U4
3/8	U6	100,000 (6,896)	43F53M16HU6	60F53H4U6	60F53H6U6	60F53H9U6
9/16	U9	100,000 (6,896)	43F53M16HU9	60F53H4U9	60F53H6U9	60F53H9U9
5/16	U5	150,000 (10,344)	43F53M16HU5	60F53H4U5	60F53H6U5	60F53H9U5

\* The pressure rating of any adapter is the value of the lowest rated connection in the fitting.

# High Pressure—Tubing



## Tubing

HiFluid supplies a complete range of high-pressure tubing for connections between components. Made from high-strength cold-drawn seamless 316SS, the tubing offers excellent pressure resistance and connection reliability under high-pressure conditions. It meets the nickel-content requirements of GB 50156-2021 for hydrogen refueling facilities.

HiFluid can also provide cone-threaded tubing on request for rapid connections or customized installations in high-pressure systems. A full range of sizes is available, and thread forms and lengths can be customized to meet diverse installation requirements.



- Needle Valves
- Check Valves
- Relief Valves
- Filters
- Fittings
- Adapters and Couplings
- Tubing**

### Dimensions

O.D. Size in. (mm)	Tolerance O.D in. (mm)
1 (25.4)	0.995/0.990 (25.273/25.174)
1/4 (6.35)	0.248/0.243 (6.299/6.172)
3/8 (9.53)	0.370/0.365 (9.398/9.271)
9/16 (14.29)	0.557/0.552 (14.147/14.021)

### Model Data

Type	Tube Material	Connection Type	Tube Size in. (mm)		Working Pressure psi (bar)				
			O.D.	I.D.	-198°C to 37°C (-325°F to 100°F)	93°C (200°F)	204°C (400°F)	315°C (600°F)	426°C (799°F)
43T16-316	316SS	M16HF	1 (25.4)	0.438 (11.1)	43,000 (2,965)	38,700 (2,668)	35,830 (2,470)	32,480 (2,240)	31,050 (2,141)
60T4-316	316SS	H4F	1/4 (6.35)	0.083 (2.11)	60,000 (4,137)	58,500 (4,050)	53,950 (3,750)	49,400 (3,400)	46,800 (3,250)
60T6 - 316	316SS	H6F	3/8 (9.53)	0.125 (3.18)	60,000 (4,137)	58,500 (4,050)	53,950 (3,750)	49,400 (3,400)	46,800 (3,250)
60T6 - 316	316SS	H9F	9/16 (14.29)	0.188 (4.77)	60,000 (4,137)	58,500 (4,050)	53,950 (3,750)	49,400 (3,400)	46,800 (3,250)

- Low Pressure
- Medium Pressure
- High Pressure
- Ultra-High Pressure
- Technical Information

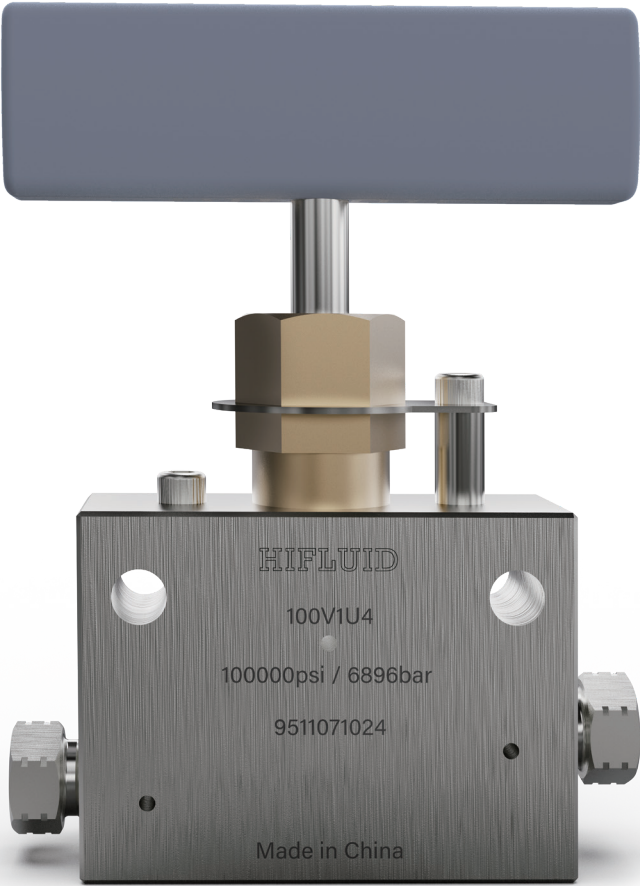

# Ultra-High Pressure

to 100,000psi (6,896bar), 150,000psi (10,344bar)

HiFluid's Ultra High Pressure product portfolio comprises needle valves (hand-operated), Actuator needle valves, check valves, fittings and tubing. All valve and fitting interfaces adopt the cone-and-thread connection, providing excellent sealing performance and stable pressure resistance.



## Needle Valves (Hand-Operated)

A needle valve controls gas or liquid flow by manually adjusting the stem travel.

Each valve body is laser-etched with model, serial number, maximum working pressure, and primary material to ensure full traceability and compliance with standardized quality control.

### Features

- Non-rotating rising stem design minimizes wear between needle and seat, extending service life.
- High-strength stainless steel duplex wetted parts and 17-4PH stem for outstanding mechanical strength and excellent corrosion resistance.
- Metal-to-metal seating provides long-term stability under high pressure and frequent cycling.
- A safety weep hole is provided between the connection and the sealing surface for leak detection and pressure release.



### Needle Valves

Hand-Operated Actuator

Check Valves

Fittings

Adapters and Couplings

Tubing

## Actuator Needle Valves

An actuator needle valve uses an air actuator to open/close the needle for remote automation. The piston-type actuator runs smoothly with fast response, suitable for a variety of industrial automation scenarios.

HiFluid offers both normally-open (NO) and normally-closed (NC) versions to match system logic. Actuators are available in light- and heavy-duty versions to accommodate different driving pressures.

### Features

- Actuators are made of anodized aluminum, which provides good corrosion resistance.
- Mechanical position indicator provided as standard; optional limit switches are available for remote monitoring or system integration.
- Spring-return design as standard; double-acting construction available according to application requirements.
- Except for the actuator, all performance characteristics are identical to the hand-operated needle valves.



# Ultra-High Pressure—Needle Valves (Hand-Operated)

## Selection Example

100		V1		U5	
Pressure Rating		Body Pattern		Connection Size	
100	100,000psi	V1	2-Way Straight	U4	1/4"
		V2	2-Way Angle	U5	5/16"
		V3	3-Way, 2 on Pressure	U6	3/8"
				U9	9/16"

## Flow Coefficient

O.D. Size in.(mm)	Connection Type	Orifice Size in.(mm)	Rated (Cv*)	Pressure Rating @R.T.(psi (bar))**
1/4 (6.35)	U4F	0.062 (1.6)	0.09	100,000 (6,896)
5/16 (7.94)	U5F	0.062 (1.6)	0.09	100,000 (6,896)
3/8 (9.53)	U6F	0.062 (1.6)	0.09	100,000 (6,896)
9/16 (14.29)	U9F	0.062 (1.6)	0.09	100,000 (6,896)



Needle Valves  
Hand-Operated  
Actuator  
Check Valves  
Fittings  
Adapters and Couplings  
Tubing

## Flow Curve

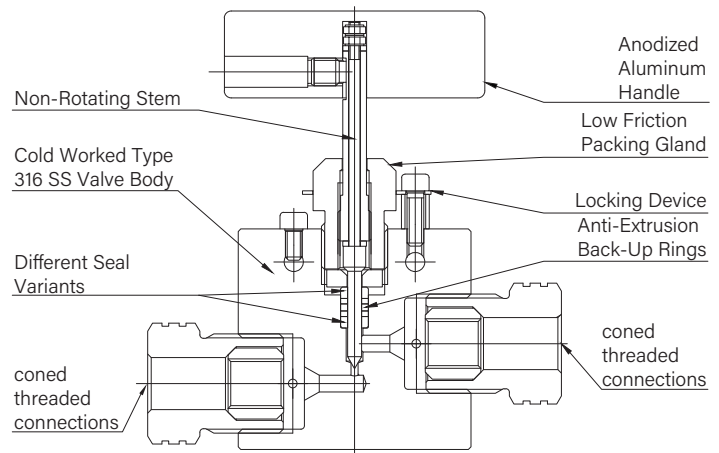
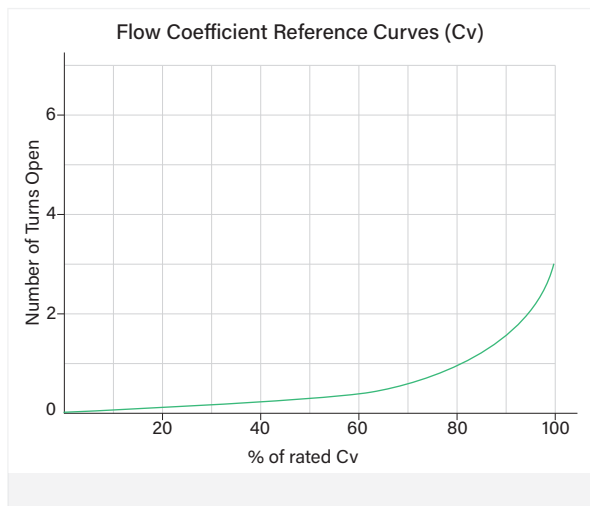

\* Cv values shown are for 2-way straight pattern vee stem valves. For 2-way angle patterns, increase the Cv value by 50%.

\*\* For the pressure-temperature relationship, refer to the guidance in the "Technical Information" section.

# Ultra-High Pressure—Needle Valves (Hand-Operated)

## Dimensions

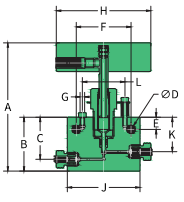
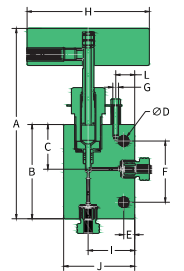
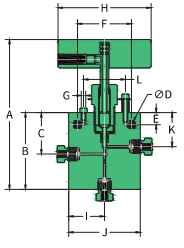
Valve Pattern	Type	O.D. Size in.	Orifice in. (mm)	Dimensions in. (mm)										Valve Panel Hole	Block Thickness	
				A	B	C	D	E	F	H	I	J	K			L
<b>2-Way Straight</b>																
	100V1U4	1/4	0.062 (1.6)	5.34 (135.5)	2.24 (57)	1.75 (44.5)	0.34 (8.5)	0.51 (13)	2.28 (58)	3.94 (100)		3.03 (77)	1.44 (36.5)	1.77 (45)	1.00 (25.4)	1.26 (32)
	100V1U5	5/16	0.062 (1.6)	5.34 (135.5)	2.24 (57)	1.75 (44.5)	0.34 (8.5)	0.51 (13)	2.28 (58)	3.94 (100)		3.03 (77)	1.44 (36.5)	1.77 (45)	1.00 (25.4)	1.26 (32)
	100V1U6	3/8	0.062 (1.6)	5.34 (135.5)	2.24 (57)	1.75 (44.5)	0.34 (8.5)	0.51 (13)	2.28 (58)	3.94 (100)		3.03 (77)	1.44 (36.5)	1.77 (45)	1.00 (25.4)	1.26 (32)
	100V1U9	9/16	0.062 (1.6)	5.72 (145.3)	2.64 (67)	1.79 (45.5)	0.34 (8.5)	0.51 (13)	1.77 (45)	3.94 (100)		2.64 (67)	1.40 (35.5)	1.77 (45)	1.00 (25.4)	1.54 (39)
<b>2-Way Angle</b>																
	100V2U4	1/4	0.062 (1.6)	6.12 (155.5)	3.03 (77)	1.44 (36.5)	0.34 (8.5)	0.35 (9)	1.97 (50)	3.94 (100)	1.50 (38)	2.28 (58)		0.61 (15.5)	1.00 (25.4)	1.26 (32)
	100V2U5	5/16	0.062 (1.6)	6.12 (155.5)	3.03 (77)	1.44 (36.5)	0.34 (8.5)	0.35 (9)	1.97 (50)	3.94 (100)	1.50 (38)	2.28 (58)		0.61 (15.5)	1.00 (25.4)	1.26 (32)
	100V2U6	3/8	0.062 (1.6)	6.12 (155.5)	3.03 (77)	1.44 (36.5)	0.34 (8.5)	0.35 (9)	1.97 (50)	3.94 (100)	1.50 (38)	2.28 (58)		0.61 (15.5)	1.00 (25.4)	1.26 (32)
	100V2U9	9/16	0.062 (1.6)	6.05 (153.5)	2.95 (75)	1.40 (35.5)	0.34 (8.5)	0.51 (13)	1.77 (45)	3.94 (100)	1.32 (33.5)	2.64 (67)		0.61 (15.5)	1.00 (25.4)	1.54 (39)
<b>3-Way, 2 on Pressure</b>																
	100V3U4	1/4	0.062 (1.6)	6.34 (161)	3.25 (82.5)	1.75 (44.5)	0.34 (8.5)	0.51 (13)	2.28 (58)	3.94 (100)	1.52 (38.5)	3.03 (77)	1.44 (36.5)	1.77 (45)	1.00 (25.4)	1.26 (32)
	100V3U5	5/16	0.062 (1.6)	6.34 (161)	3.25 (82.5)	1.75 (44.5)	0.34 (8.5)	0.51 (13)	2.28 (58)	3.94 (100)	1.52 (38.5)	3.03 (77)	1.44 (36.5)	1.77 (45)	1.00 (25.4)	1.26 (32)
	100V3U6	3/8	0.062 (1.6)	6.34 (161)	3.25 (82.5)	1.75 (44.5)	0.34 (8.5)	0.51 (13)	2.28 (58)	3.94 (100)	1.52 (38.5)	3.03 (77)	1.44 (36.5)	1.77 (45)	1.00 (25.4)	1.26 (32)
	100V3U9	9/16	0.062 (1.6)	6.36 (161.5)	3.25 (82.5)	1.81 (46)	0.34 (8.5)	0.51 (13)	1.77 (45)	3.94 (100)	1.32 (33.5)	2.64 (67)	1.40 (35.5)	1.77 (45)	1.00 (25.4)	1.54 (39)

Note: Dimensions are for reference only; contact HiFluid for further requirements.

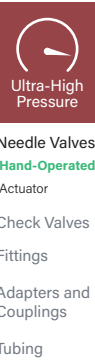

Ultra-High Pressure

- Needle Valves
- Hand-Operated
- Actuator
- Check Valves
- Fittings
- Adapters and Couplings
- Tubing

Pressure to 100,000psi (6,896bar), 150,000psi (10,344bar)

# Ultra-High Pressure—Actuator Needle Valves

## Selection Example

100		V1		U5		-HNC	
Pressure Rating		Body Pattern		Connection Size		Options	
100	100,000psi	V1	2-Way Straight	U4	1/4"	MNO	Light-Duty NO
		V2	2-Way Angle	U5	5/16"	HNO	Heavy-Duty NO
				U6	3/8"	MNC	Light-Duty NC
				U9	9/16"	HNC	Heavy-Duty NC
						MDA	Light-Duty DA
						HDA	Heavy-Duty DA

Note: For working pressure, please see "Technical Data".



- Needle Valves
- Hand-Operated
- Actuator
- Normally-Open
- Normally-Closed
- Double-Acting
- Check Valves
- Fittings
- Adapters and Couplings
- Tubing

Pressure to 100,000psi (6,896bar), 150,000psi (10,344bar)

# Ultra-High Pressure—Actuator Needle Valves—Normally-Open

**HIFLUID**

## Dimensions

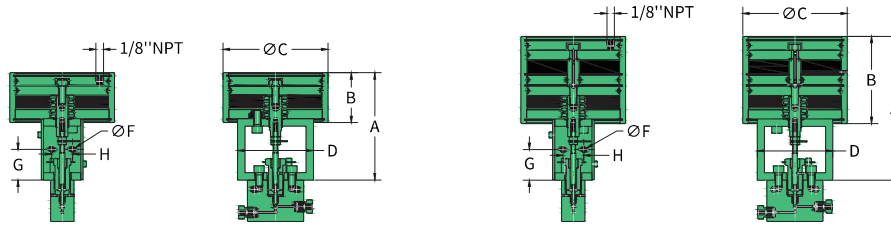

Actuator Type	Suffix	Piston Area in. <sup>2</sup> (mm <sup>2</sup> )	Dimensions in. (mm)						
			A	B	C	D	F	G	H
Light Duty	4;6;9-MNO	19.6 (12.645)	5.79 (147.3)	2.69 (68.3)	5.67 (144)	4.09 (104)	0.28 (7)	1.65 (42)	1.13 (28.8)
Heavy Duty	4;6;9-HNO	39.2 (25.290)	7.78 (197.8)	4.72 (119.9)	5.67 (144)	4.09 (104)	0.28 (7)	1.65 (42)	1.13 (28.8)
Light Duty	5-MNO	19.6 (12.645)	5.79 (147.3)	2.69 (68.3)	5.67 (144)	4.09 (104)	0.28 (7)	1.65 (42)	1.13 (28.8)
Heavy Duty	5-HNO	39.2 (25.290)	7.78 (197.8)	4.72 (119.9)	5.67 (144)	4.09 (104)	0.28 (7)	1.65 (42)	1.13 (28.8)

-  Ultra-High Pressure
- Needle Valves
- Hand-Operated Actuator
- Normally-Open
- Normally-Closed
- Double-Acting
- Check Valves
- Fittings
- Adapters and Couplings
- Tubeing

## Technical Data

Pre-ssure Rating	O.D. Size in.	Air Actuator		Air pressure required to close Valve at: System Pressure ksi (bar)										Max. Pressure psi (bar)	Stem Travel in. (mm)	Flow Coefficient Cv*
		Type	Suffix	1-10 (68-689)	20 (1,379)	30 (2,068)	40 (2,758)	50 (3,447)	60 (4,137)	70 (4,826)	80 (5,516)	90 (6,205)	100 (6,896)			
100	1/4	Light Duty	-MNO	50	50	50	50	55	65	75	85	95	100	100,000 (6,896)	0.12 (3)	0.09
	5/16			30	30	30	30	30	35	40	40	45	50			
	3/8	Heavy Duty	-HNO	30	30	30	30	30	35	40	40	45	50			
	9/16			2.1	2.1	2.1	2.1	2.1	2.1	2.4	2.8	2.8	3.1	3.5		

\* Cv values are for straight pattern valves, increase this value by 50% for angle pattern valves.

Pressure to 100,000psi (6,896bar), 150,000psi (10,344bar)

# Ultra-High Pressure—Actuator Needle Valves—Normally-Closed **HIFLUID**

## Dimensions

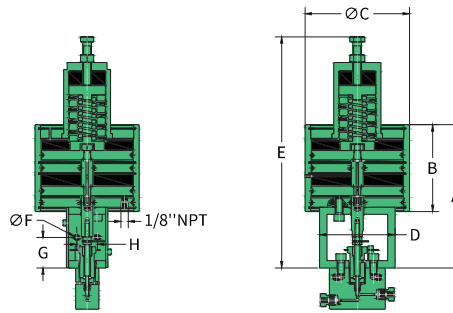

Actuator Type	Suffix	Piston Area in. <sup>2</sup> (mm <sup>2</sup> )	Dimensions in. (mm)							
			A	B	C	D	E*	F	G	H
Heavy Duty	4;5;6;9-HNC	39.2 (25,290)	7.78 (197.8)	4.72 (119.9)	5.67 (144)	4.09 (104)	12.59 (320)	0.28 (7)	1.65 (42)	1.13 (28.8)

\*E dimension is an approximation only.

## Technical Data

Pre-ssure Rating	O.D. Size in.	Air Actuator			Air pressure required to open Valve at: System Pressure ksi (bar)									Max. Pressure psi (bar)	Flow Coefficient Cv*
		Type	Suffix	Data	1-10 (68-680)	20 (1,400)	30 (2,000)	40 (2,800)	50 (3,500)	60 (4,100)	70 (4,800)	80 (5,500)	90 (6,207)		
100	1/4	Heavy Duty	-HNC	Air Pressure psi(bar)	35 (2.4)	35 (2.4)	40 (2.8)	40 (2.8)	45 (3.1)	50 (3.5)	55 (3.8)	60 (4.2)	70 (4.9)	90,000 (6,207)	0.09-0.07
	5/16			Spring Pre-Compression in. (mm)	0.12 (3)	0.12 (3)	0.19 (4.8)	0.19 (4.8)	0.22 (5.6)	0.25 (6.4)	0.28 (7.1)	0.31 (7.9)	0.38 (9.7)		
	3/8			Stem Travel in.(mm)	0.12 (3)	0.12 (3)	0.12 (3)	0.12 (3)	0.12 (3)	0.12 (3)	0.12 (3)	0.12 (3)	0.12 (3)		
	9/16														

\* Cv values are for straight pattern valves, increase this value by 50% for angle pattern valves.

Cv values vary due to compression of actuator spring, and are adjusted based on system pressure. Values shown are for maximum to minimum stem travel position.



- Needle Valves
- Hand-Operated Actuator
- Normally-Open
- Normally-Closed**
- Double-Acting
- Check Valves
- Fittings
- Adapters and Couplings
- Tubing

Pressure to 100,000psi (6,896bar), 150,000psi (10,344bar)







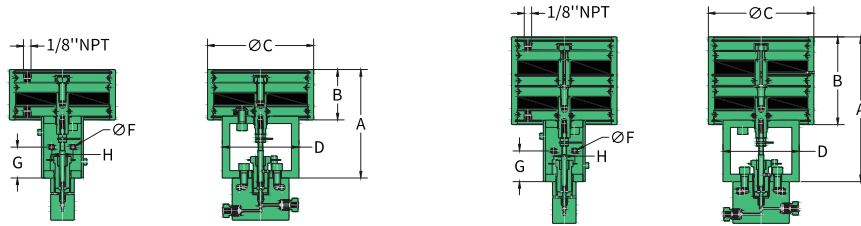



# Ultra-High Pressure—Actuator Needle Valves—Double-Acting

**HIFLUID**

## Dimensions



Actuator Type	Suffix	Piston Area in. <sup>2</sup> (mm <sup>2</sup> )	Dimensions in. (mm)						
			A	B	C	D	F	G	H
Light Duty	4;6;9-MDA	19.6 (12.645)	5.79 (147.3)	2.69 (68.3)	5.67 (144)	4.09 (104)	0.28 (7)	1.65 (42)	1.13 (28.8)
Heavy Duty	4;6;9-HDA	39.2 (25.290)	7.78 (197.8)	4.72 (119.9)	5.67 (144)	4.09 (104)	0.28 (7)	1.65 (42)	1.13 (28.8)
Light Duty	5-MDA	19.6 (12.645)	5.79 (147.3)	2.69 (68.3)	5.67 (144)	4.09 (104)	0.28 (7)	1.65 (42)	1.13 (28.8)
Heavy Duty	5-HDA	39.2 (25.290)	7.78 (197.8)	4.72 (119.9)	5.67 (144)	4.09 (104)	0.28 (7)	1.65 (42)	1.13 (28.8)

-  Ultra-High Pressure
-  Needle Valves
-  Hand-Operated Actuator
-  Normally-Open
-  Normally-Closed
-  Double-Acting
-  Check Valves
-  Fittings
-  Adapters and Couplings
-  Tubing

## Technical Data

Pre-ssure Rating	O.D. Size in.	Air Actuator		Air pressure required to close Valve at: System Pressure ksi (bar)										Max. Pressure psi (bar)	Stem Travel in.(mm)	Flow Coefficient Cv*
		Type	Suffix	1-10 (68-689)	20 (1,379)	30 (2,068)	40 (2,758)	50 (3,447)	60 (4,137)	70 (4,826)	80 (5,516)	90 (6,207)	100 (6,897)			
100	1/4	Light Duty	-MDA	50 (3.5)	50 (3.5)	50 (3.5)	50 (3.5)	55 (3.8)	65 (4.5)	75 (5.2)	85 (5.9)	95 (6.6)	100 (6.9)	100,000 (6,896)	0.12 (3)	0.09
	5/16	Heavy Duty	-HDA	30 (2.1)	30 (2.1)	30 (2.1)	30 (2.1)	30 (2.1)	35 (2.4)	40 (2.8)	40 (2.8)	45 (3.1)	50 (3.5)			
	3/8															
	9/16															

\* Cv values are for straight pattern valves, increase this value by 50% for angle pattern valves.



## Ball Check Valves

A ball check valve controls one-way flow using a spherical element. When differential pressure drops below the set opening pressure, the valve automatically closes to prevent backflow—ideal where sealing requirements are relatively lower, but backflow must be avoided.

HiFluid ball check valves are suitable for service up to 349°C (660°F). The opening pressure of the ball check valves is approx. 20psi (1.38bar),  $\pm 30\%$ .



Needle Valves

**Check Valves**  
Ball Check

Fittings

Adapters and  
Couplings

Tubing

Pressure to 100,000psi (6,896bar), 150,000psi (10,344bar)

# Ultra-High Pressure—Ball Check Valves

**HIFLUID**

## Selection Example

100		V62		U5	
Pressure Rating		Component Type		Connection Size	
100	100,000psi	V62	Ball Check Valve	U4	1/4"
				U5	5/16"
				U6	3/8"
				U9	9/16"

## Dimensions

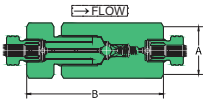
Valve Pattern	Type	Connection Type	Max. Pressure psi (bar)	Orifice in. (mm)	Rated (Cv)	Dimensions in. (mm)	
						A(HEX.)	B
<b>Ball Check Valves</b>							
	100V62U4	U4F	100,000 (6,896)	0.094 (2.3)	0.15	1.18 (30)	3.38 (85.7)
	100V62U5	U5F	100,000 (6,896)	0.062 (1.6)	0.11	1.63 (41.3)	5.42 (137.6)
	100V62U6	U6F	100,000 (6,896)	0.125 (3.2)	0.28	1.18 (30)	3.81 (96.8)
	100V62U9	U9F	100,000 (6,896)	0.188 (4.8)	0.63	1.63 (41.3)	4.62 (117.4)



Needle Valves  
 Check Valves  
**Ball Check**  
 Fittings  
 Adapters and Couplings  
 Tubing



## Accessories

All ultra-high pressure fittings are supplied with glands and collars to ensure sealing integrity and connection stability during field installation. Users may also purchase glands and collars separately as needed for more flexible system configuration.

## Straight Coupling, Elbow, Tee, Cross

HiFluid supplies a full range of straight coupling, elbow, tee, and cross fittings for multi-directional connections in ultra-high pressure systems. All interfaces adopt the ultra-high pressure cone-and-thread design to ensure reliable sealing and stable connections under ultra-high pressure conditions.



- Needle Valves
- Check Valves
- Fittings**
- Accessories
- Straight Coupling
- Elbow, Tee, Cross
- Adapters and Couplings
- Tubing

Pressure to 100,000psi (6,896bar), 150,000psi (10,344bar)





# Ultra-High Pressure—Accessories

**HIFLUID**

## Selection Example

100		F71		U4	
Pressure Rating		Component Type		Connection Size	
100	100,000psi	F71	Gland	U4	1/4"
150 (only U5)	150,000psi	F72	Collar	U5	5/16" (only 150 series)
		F73	Plug	U6	3/8"
		F74	Tubing Cap	U9	9/16"

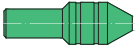
## Dimensions

O.D.Size in. (mm)	Gland	Collar	Plug	Tubing Cap
				
1/4 (6.35)	100F71U4	100F72U4	100F73U4	100F74U4
3/8 (9.53)	100F71U6	100F72U6	100F73U6	100F74U6
9/16 (14.29)	100F71U9	100F72U9	100F73U9	100F74U9
5/16 (7.94)	150F71U5	150F72U5	150F73U5	150F74U5



- Needle Valves
- Check Valves
- Fittings**
- Accessories
- Straight Coupling
- Elbow, Tee, Cross
- Adapters and Couplings
- Tubing

Pressure to 100,000psi (6,896bar), 150,000psi (10,344bar)

**HIFLUID**

# Ultra-High Pressure—Straight Coupling, Elbow, Tee, Cross

## Selection Example

100		F2		U6	
Pressure Rating		Body Pattern		Connection Size	
100	100,000psi	F1	Straight Coupling	U4	1/4"
150 (only U5)	150,000psi	F2	Elbow	U5	5/16" (only 150 series)
		F3	Tee	U6	3/8"
		F4	Cross	U9	9/16"

## Dimensions

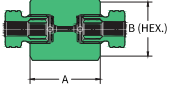
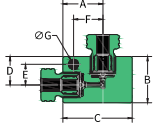
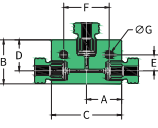
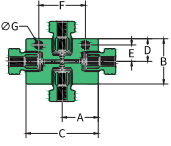
Body Pattern	Type	Connection Type	O.D. Size in.	Orifice in. (mm)	Dimensions in. (mm)							Block Thickness
					A	B	C	D	E	F	G	
<b>Straight Coupling</b>												
	100F1U4	U4F	1/4	0.094 (2.3)	1.38 (35)	1.06 (27)						
	100F1U6	U6F	3/8	0.125 (3.2)	1.77 (45)	1.06 (27)						
	100F1U9	U9F	9/16	0.188 (4.8)	2.19 (55.6)	1.46 (37)						
	150F1U5	U5F	5/16	0.094 (2.3)	2.64 (67)	1.19 (30)						
<b>Elbow</b>												
	100F2U4	U4F	1/4	0.094 (2.3)	0.89 (22.6)	1.02 (25.9)	1.54 (39)	0.63 (16)	0.46 (11.7)	0.65 (16.5)	0.22 (5.6)	1.02 (26)
	100F2U6	U6F	3/8	0.125 (3.2)	1.26 (32)	1.50 (38.1)	2.01 (51)	0.98 (24.9)	0.72 (18.3)	0.69 (17.5)	0.26 (6.6)	1.02 (26)
	100F2U9	U9F	9/16	0.188 (4.8)	1.89 (48)	1.89 (48)	2.64 (67)	1.10 (28)	0.83 (21.1)	0.94 (23.9)	0.33 (8.4)	1.54 (39)
	150F2U5	U5F	5/16	0.094 (2.3)	1.52 (38.6)	2.13 (54.1)	3.03 (77)	1.52 (38.6)	0.92 (23.4)	0.92 (23.4)	0.33 (8.4)	1.26 (32)
<b>Tee</b>												
	100F3U4	U4F	1/4	0.094 (2.3)	1.00 (25.4)	1.26 (32)	2.01 (51)	0.89 (22.6)	0.46 (11.7)	1.30 (33)	0.22 (5.6)	1.02 (26)
	100F3U6	U6F	3/8	0.125 (3.2)	1.00 (25.4)	1.57 (39.9)	2.01 (51)	1.06 (26.9)	0.72 (18.3)	1.38 (35)	0.26 (6.6)	1.02 (26)
	100F3U9	U9F	9/16	0.188 (4.8)	1.32 (33.5)	2.13 (54.1)	2.64 (67)	1.38 (35)	0.83 (21.1)	1.89 (48)	0.34 (8.4)	1.54 (39)
	150F3U5	U5F	5/16	0.094 (2.3)	1.52 (38.6)	2.13 (54.1)	3.03 (77)	1.52 (38.6)	0.92 (23.4)	1.83 (46.5)	0.33 (8.4)	1.26 (32)
<b>Cross</b>												
	100F4U4	U4F	1/4	0.094 (2.3)	1.00 (25.4)	1.26 (32)	2.01 (51)	0.63 (16)	0.46 (11.7)	1.30 (33)	0.22 (5.6)	1.02 (26)
	100F4U6	U6F	3/8	0.125 (3.2)	1.00 (25.4)	2.13 (54.1)	2.01 (51)	1.06 (27)	0.72 (18.3)	1.38 (35)	0.26 (6.6)	1.02 (26)
	100F4U9	U9F	9/16	0.188 (4.8)	1.32 (33.5)	2.76 (70.1)	2.64 (67)	1.38 (35)	0.83 (21.1)	1.89 (48)	0.33 (8.4)	1.54 (39)
	150F4U5	U5F	5/16	0.094 (2.3)	1.52 (38.6)	3.03 (77)	3.03 (77)	1.52 (38.6)	0.92 (23.4)	1.83 (46.5)	0.33 (8.4)	1.26 (32)

-  Ultra-High Pressure
- Needle Valves
- Check Valves
- Fittings
- Accessories
- Straight Coupling
- Elbow, Tee, Cross
- Adapters and Couplings
- Tubing



## Adapters (Male to Female)

HiFluid male to female adapters convert between different thread types or sizes, connecting a female thread to a male thread. Both ends may use different thread forms and sizes to meet installation needs under complex conditions.

The adapter's pressure rating is limited by the lower rating of the two ends. Naming rule: list the female size first, then the male size.

## Couplings (Female to Female)

HiFluid female to female couplings convert between different thread types or sizes, connecting two male threads. Both ends may use different thread forms and sizes to meet installation needs under complex conditions.

The pressure rating is limited by the lower rating of the two ends. Naming rule: under the same pressure rating, list the smaller size first; if ratings differ, list the lower-pressure first.



## Adapters (Male to Male)

HiFluid male to male adapters convert between different thread types or sizes, connecting two female threads. Both ends may use different thread forms and sizes to meet installation needs under complex conditions.

The pressure rating is limited by the lower rating of the two ends. Naming rule: under the same pressure rating, list the smaller size first; if ratings differ, list the lower-pressure first.



Ultra-High Pressure

Needle Valves

Check Valves

Fittings

**Adapters and Couplings**

Adapters (Male to Female)

Couplings (Female to Female)

Adapters (Male to Male)

Tubing

Pressure to 100,000psi (6,896bar), 150,000psi (10,344bar)

# Ultra-High Pressure—Adapters (Male to Female)

## Selection Example

100		F51		U6		U4	
Pressure Rating		Component Type		Female Size		Male Size	
100	100,000psi	F51	Adapters (Male to Female)	U4	1/4"	U4-1/4"	
150 (only U5)	150,000psi			U6	3/8"	U6-3/8"	
				U9	9/16"	U9-9/16"	
				U5	5/16" (only 150 series)	U5-5/16" (only 150 series)	

## Model Data

Male			Female			
O.D. Size in.	Connection Type	Max. Pressure psi (bar)*	100,000psi (6,896bar)			150,000 (10,344)
			1/4"U4	3/8"U6	9/16"U9	5/16" U5
Ultra-High Pressure			Ultra-High Pressure			
1/4	U4	100,000 (6,896)	100F51U4	100F51U6U4	100F51U9U4	100F51U5U4
3/8	U6	100,000 (6,896)	100F51U4U6	100F51U6	100F51U9U6	100F51U5U6
9/16	U9	100,000 (6,896)	100F51U4U9	100F51U6U9	100F51U9	100F51U5U9
5/16	U5	150,000 (10,344)	100F51U4U5	100F51U6U5	100F51U9U5	150F51U5

\* The pressure rating of any adapter is the value of the lowest rated connection in the fitting.



- Needle Valves
- Check Valves
- Fittings
- Adapters and Couplings
- Adapters (Male to Female)
- Couplings (Female to Female)
- Adapters (Male to Male)
- Tubing

Pressure to 100,000psi (6,896bar), 150,000psi (10,344bar)

# Ultra-High Pressure—Couplings (Female to Female)

## Selection Example

100		F52		U4		U6	
Pressure Rating		Component Type		Female Size		Female Size	
100	100,000psi	F52	Couplings (Female to Female)	U4	1/4"	U4-1/4"	
150 (only U5)	150,000psi			U6	3/8"	U6-3/8"	
				U9	9/16"	U9-9/16"	
				U5	5/16" (only 150 series)	U5-5/16" (only 150 series)	

## Model Data

Female			Female			
O.D. Size in.	Connection Type	Max. Pressure psi (bar)*	100,000psi (6,896bar)		150,000 psi (10,344 bar)	
			1/4" U4	3/8" U6	9/16" U9	5/16" U5
Ultra-High Pressure			Ultra-High Pressure			
1/4	U4	100,000 (6,896)		100F52U4U6	100F52U4U9	100F52U4U5
3/8	U6	100,000 (6,896)			100F52U6U9	100F52U5U6
9/16	U9	100,000 (6,896)				100F52U5U9

\* The pressure rating of any adapter is the value of the lowest rated connection in the fitting.



- Needle Valves
- Check Valves
- Fittings
- Adapters and Couplings
- Adapters (Male to Female)
- Couplings (Female to Female)
- Adapters (Male to Male)
- Tubing

Pressure to 100,000psi (6,896bar), 150,000psi (10,344bar)

# Ultra-High Pressure—Adapters (Male to Male)

## Selection Example

100		F53		U4		U6	
Pressure Rating		Component Type		Male Size		Male Size	
100	100,000psi	F53	Adapters (Male to Male)	U4	1/4"	U4-1/4"	
150 (only U5)	150,000psi			U6	3/8"	U6-3/8"	
				U9	9/16"	U9-9/16"	
				U5	5/16" (only 150 series)	U5-5/16" (only 150 series)	

## Model Data

Male			Male			
O.D. Size in.	Connection Type	Max. Pressure psi (bar)*	100,000 psi (6,896 bar)			150,000 (10,344)
			1/4"U4	3/8"U6	9/16"U9	5/16" U5
Ultra-High Pressure			Ultra-High Pressure			
1/4	U4	100,000 (6,896)	100F53U4	100F53U4U6	100F53U4U9	100F53U4U5
3/8	U6	100,000 (6,896)		100F53U6	100F53U6U9	100F53U5U6
9/16	U9	100,000 (6,896)			100F53U9	100F53U5U9
5/16	U5	150,000 (10,344)				150F53U5

\* The pressure rating of any adapter is the value of the lowest rated connection in the fitting.



- Needle Valves
- Check Valves
- Fittings
- Adapters and Couplings**
- Adapters (Male to Female)
- Couplings (Female to Female)
- Adapters (Male to Male)**
- Tubing

# Ultra-High Pressure—Tubing



## Tubing

HiFluid supplies a complete range of ultra-high pressure tubing for connections between components. Made from high-strength cold-drawn seamless 316SS or HP160 stainless steel seamless pipes, the tubing offers excellent pressure resistance and connection reliability under ultra-high pressure conditions.

HiFluid can also provide cone-threaded tubing on request for rapid connections or customized installations in medium-pressure systems. A full range of sizes is available, and thread forms and lengths can be customized to meet diverse installation requirements.

### Dimensions

O.D. Size in. (mm)	Tolerance O.D in. (mm)
1/4 (6.35)	0.248/0.243 (6.299/6.172)
3/8 (9.53)	0.370/0.365 (9.398/9.271)
9/16 (14.29)	0.557/0.552 (14.147/14.021)
5/16 (7.94)	0.310/0.306 (7.874/7.72)

### Model Data

Type	Tube Material	Connection Type	Tube Size in. (mm)		Working Pressure psi (bar)				
			O.D.	I.D.	-198°C to 37°C (-325°F to 100°F)	93°C (200°F)	204°C (400°F)	315°C (600°F)	426°C (799°F)
100T4-HP160	HP160	U4F	1/4 (6.35)	0.06 (1.59)	100,000 (6,896)	82,600 (5,695)	72,600 (5,006)	66,500 (4,585)	61,500 (4,240)
100T6-HP160	HP160	U6F	3/8 (9.53)	0.125 (3.20)	100,000 (6,896)	82,600 (5,695)	72,600 (5,006)	66,500 (4,585)	61,500 (4,240)
100T9-HP160	HP160	U9F	9/16 (14.29)	0.188 (4.77)	100,000 (6,896)	82,600 (5,695)	72,600 (5,006)	66,500 (4,585)	61,500 (4,240)
150T5-HP160	HP160	U5F	5/16 (7.94)	0.062 (1.58)	150,000 (10,344)	124,000 (8,550)	108,800 (7,500)	99,800 (6,880)	92,200 (6,355)
150T5-316	316SS	U5F	5/16 (7.94)	0.062 (1.58)	150,000 (10,344)	136,800 (9,432)	126,160 (8,700)	115,520 (7,965)	109,440 (7,546)



- Needle Valves
- Check Valves
- Fittings
- Adapters and Couplings
- Tubing**

- Low Pressure
- Medium Pressure
- High Pressure
- Ultra-High Pressure
- Technical Information



# Technical Information

This section provides guidance to help engineers select the proper HiFluid brand ultra-high-pressure valves, fittings and tubing. The data presented are not product specifications but recommendations for correct use.

For demanding conditions, selecting suitable components is critical to system service life. HiFluid’s engineering team is available to assist with interpretation of this information.

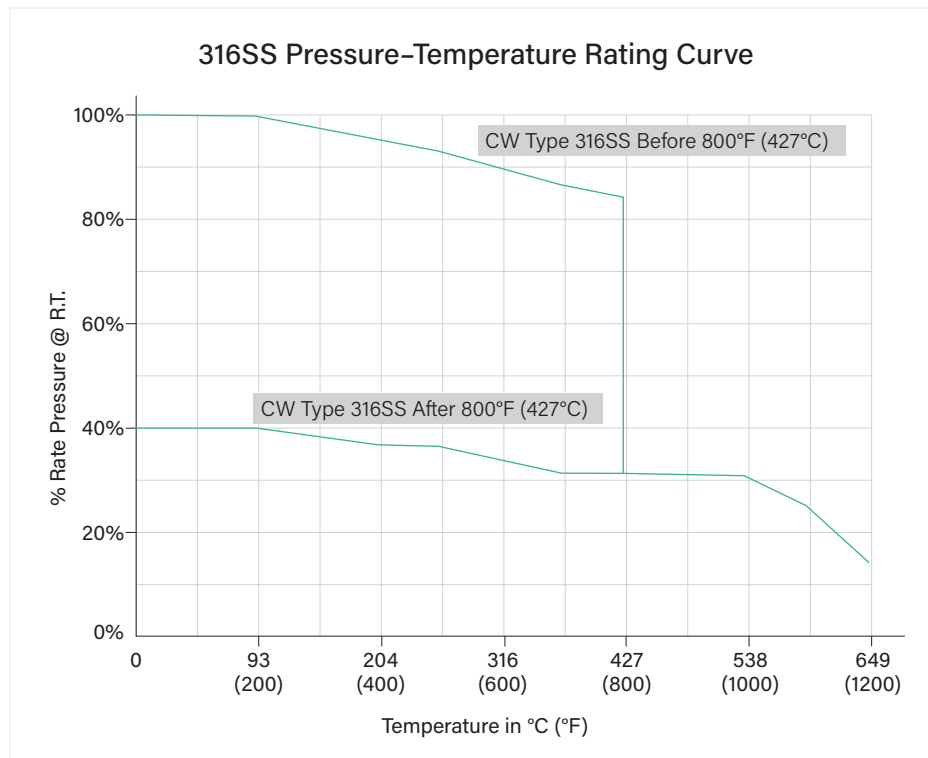

Note: 1. The curve is for reference only and may be affected by the pressure–temperature properties of other materials. For special requirements, consult HiFluid for recommended body and seal materials.

2. Curve is valid for cold-worked Type 316 stainless steel components as long as operating temperature does not exceed 427°C (800°F). When exceeding this temperature, the cold worked effect is PERMANENTLY altered, and the components should be considered as annealed material, using 40% of its cold-worked rating for future operation of the components.

-  Technical Information
- Basic Information
- High-Pressure Fluid Systems: Operating Conditions
- Handling of High-Pressure Tubing
- Threaded Connections in Fluid Systems
- Valve Design Types
- Installation
- Disassembly
- Maintenance
- Repair
- Annexes
- Conversation Tables

# Valves, Fitting and Tubing Temperature Table

Series	Product	Media Temperature
Low-Pressure Needle Valve	15V...	-51°C to 232°C (-60°F to 450°F)
	15V...-B	-73°C to 149°C (-100°F to 300°F)
Medium-Pressure Valves High-Pressure Valves	15V...-60V...	-51°C to 232°C (-60°F to 450°F)
	20V...-B - 60V...- B	-73°C to 149°C (-100°F to 300°F)
	20V...-TG- 60V...- TG	-51°C to 316°C (-60°F to 600°F)
	20V...-GY- 60V...- GY	-51°C to 426°C (-60°F to 799°F)
	20V...-HT- 60V...- HT	-51°C to 649°C (-60°F to 1200°F)
	20V...- LT- 60V...- LT	-253°C to 232°C (-423°F to 450°F)
Actuator Needle Valves	...M/H...	-51°C to 232°C (-60°F to 450°F)
	...- B- M/H...	-73°C to 149°C (-100°F to 300°F)
Check Valves	...V61...	-20°C to 199°C (-4°F to 390°F)
	...V62...	-201°C to 349°C (-330°F to 660°F)
Filters	...F61...	-253°C to 349°C (-423°F to 660°F)
	...F62...	-253°C to 349°C (-423°F to 660°F)
Low-Pressure Fittings	...F...	-253°C to 349°C (-423°F to 660°F)
Medium-Pressure, High-Pressure and Ultra-High Pressure Fittings, Tubing	...F... ...T...	-253°C to 349°C (-423°F to 660°F)



- Basic Information
- High-Pressure Fluid Systems: Operating Conditions
- Handling of High-Pressure Tubing
- Threaded Connections in Fluid Systems
- Valve Design Types
- Installation
- Disassembly
- Maintenance
- Repair
- Annexes
- Conversation Tables

01 Basic Information

01 High-Pressure Fluid Systems: Operating Conditions

01 Handling of High-Pressure Tubing

02 Threaded Connections in Fluid Systems

03 Valve Design Types

04 Installation

- Needle Valve (Hand-Operated) • Actuator Needle Valves
- Dual-Disc Line, Cup-Type Line and Angle Filters

05 Disassembly

05 Maintenance

05 Repair

06 Annexes

- Torque Values • Anti-Vibration Torque Values • Needle Valve Torque Values
- Recommended Bend Radius for 316SS Tubing • Tube Connection Details

11 Conversation Tables



Technical Information

Basic Information

High-Pressure Fluid Systems: Operating Conditions

Handling of High-Pressure Tubing

Threaded Connections in Fluid Systems

Valve Design Types

Installation

Disassembly

Maintenance

Repair

Annexes

Conversation Tables

# Technical Information

## Basic Information

Ultra-high-pressure valves, fittings and tubing systems play a central role in many industrial sectors. Most systems conveying liquids or gases operate under severe conditions, requiring components and threaded connections to meet strict standards.

This document provides an overview of technical data options for HiFluid ultra-high-pressure valves, fittings and tubing, and covers assembly, disassembly, maintenance and servicing.

Relevant accident-prevention regulations and generally accepted safety practices must always be observed.

## High-Pressure Fluid Systems: Operating Conditions

When designing fluid systems and selecting materials and components, basic conditions including working pressure, dynamic loads, temperature, and fluid characteristics must be considered.

In medium- and high-pressure applications, static and cyclic pressure must be accounted for. For fatigue-sensitive service, HiFluid offers autofrettaged ultra-high-pressure valves, fittings and tubing to enhance fatigue resistance. In addition, HiFluid provides 100,000 psi (6,896 bar) high-fatigue tubing which can replace standard 60,000 psi (4,137 bar) tubing to deliver longer service life at 60,000 psi.

In medium- and high-pressure applications, the working medium must also be considered. Components conveying light gases (hydrogen, helium) are much more difficult to seal than tubing conveying liquids, especially at high pressures. Generally, the higher the pressure rating of the valves, fittings and tubing, the lower the likelihood of leakage of light gases. Greater wall thickness can improve sealing performance when selecting tubing.

## Handling of High-Pressure Tubing

HiFluid high-pressure tubing is manufactured from premium cold-worked 316 stainless steel, suitable for high-pressure equipment and, in some cases, ultra-high-pressure service for liquids and gases. When handling high-pressure tubing, the following must be observed:

 As the tubing is made of cold-worked stainless steel, it must not be heated above 427°C (800°F), as higher temperatures will degrade its properties.

 High-pressure tubing must not be welded or soldered.

 When bending tubing, the recommended minimum bending radii (see Annex 4, page 8) need to be observed. A bending radius that is too small exerts excessive loads onto the tubing. Also, the cross-section of the high pressure tubing may not deform. No kinks may occur during the bending process. We recommend a bending tool with dies specific to the pipe diameter.

 Autofrettaged tubing must not be bent after treatment, or should be pre-bent before autofrettage.

The figure below shows how to properly handle high-pressure tubing:

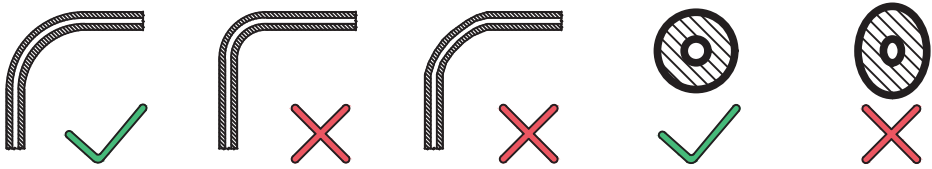

- Technical Information
- Basic Information
- High-Pressure Fluid Systems: Operating Conditions
- Handling of High-Pressure Tubing
- Threaded Connections in Fluid Systems
- Valve Design Types
- Installation
- Disassembly
- Maintenance
- Repair
- Annexes
- Conversation Tables

# Technical Information

## Threaded Connections in Fluid Systems

Threaded connections are critical to leak-free service. Cone-and-thread connections.

Options include pipe threads, ferrule connections, flange threads, and cone-and-thread connections.

### Selection Criteria

Choosing the correct threaded connection depends primarily on system pressure, but sealing type and principle are also important. Sealing methods include metal-to-metal and soft seals. For soft seals, fluid properties such as temperature, environment, flow parameters, and installation conditions must also be considered.

If the system operating pressure exceeds 15,000 psi (1,034 bar), cone-and-thread connections must be used. These consist of three parts:

- **Tube End**  
The tubing end is chamfered at 58° with a left-hand external thread.
- **Collar**  
The collar is a ring with left-hand internal threads; it transmits the load.
- **Gland**  
The gland connects with a body machined at 60°. Tightening the gland with the specified torque presses the tubing and collar into the cone seat to achieve sealing.

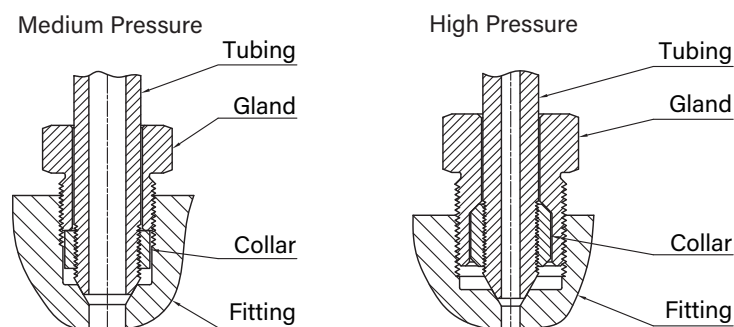

### Assembly Instructions

- Collar to tube: screw the collar onto the tube until one to two threads are exposed.
- Apply compatible lubricant to gland threads, the back of the collar, and the tubing cone. Protect sealing surfaces during assembly to avoid damage.
- Insert the tubing into the body, hand-tighten the gland, then torque to the values specified in Annex 1.



Technical  
Information

Basic  
Information

High-Pressure  
Fluid Systems:  
Operating  
Conditions

Handling of  
High-Pressure  
Tubing

**Threaded  
Connections  
in Fluid  
Systems**

Valve Design  
Types

Installation

Disassembly

Maintenance

Repair

Annexes

Conversation  
Tables

# Technical Information

## Valve Design Types

Due to the fact that high or low temperatures and fast heating or cooling speeds can impact on the sealing capability of the metal seals, the valve series should be selected after taking into account both the pressure resistance and also the static and dynamic temperature conditions. As a general rule: the smaller the sealing surface, the higher the temperature resistance. The following shows the types, design, the differences and the application ranges of these functional parts.

The figure below shows all components of valve 20V1M9, which is a straight valve.

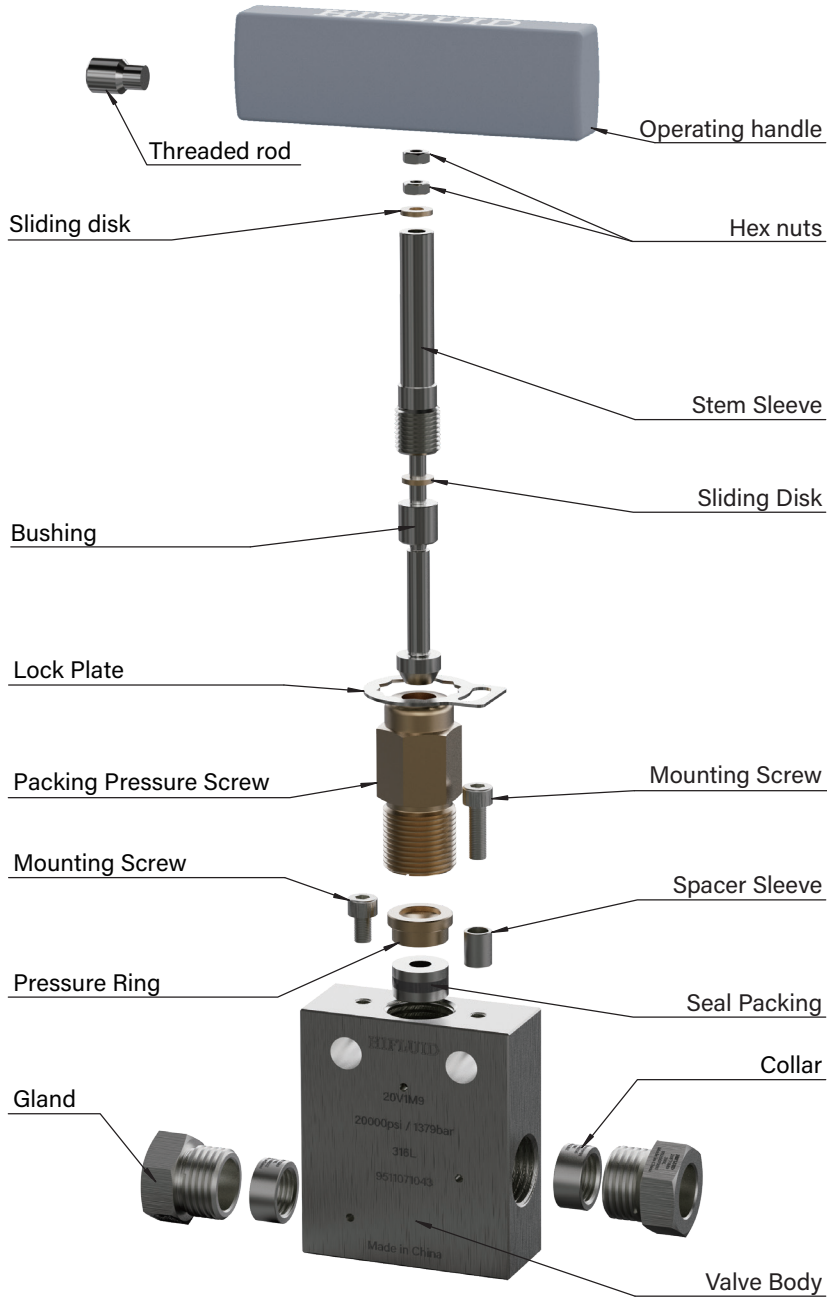

### Technical Information

- Basic Information
- High-Pressure Fluid Systems: Operating Conditions
- Handling of High-Pressure Tubing
- Threaded Connections in Fluid Systems
- Valve Design Types**
- Installation
- Disassembly
- Maintenance
- Repair
- Annexes
- Conversation Tables

# Technical Information

## Installation

### Needle Valve (for Panel Mounting)

- 01 Loosen the screw on the handle and remove the operating handle from the valve stem sleeve.
- 02 Remove the mounting screw and the lock plate.
- 03 Use the mounting screws to mount the hand-operated needle valve onto the panel. The mounting position can be freely selected (for thicker panels, longer screws may be required).
- 04 Reinsert the operating handle into the valve stem sleeve and secure it with the screw. Maximum torque: 8 Nm (for 1/4", 3/8", and 9/16" [30 Series and 60 Series], thread M8). For 9/16" (20 Series), 5/16", 3/4", and 1" (thread M10), maximum torque is 12 Nm.

Note: It is recommended to secure the hand-operated needle valve with two designated mounting holes (in addition to panel mounting). Otherwise, threaded connections may loosen when the valve is operated.

### Needle Valves (Hand-Operated)

The actuator bracket has two holes of 7 mm diameter on each side for mounting the air-operated needle valve.

### Dual-Disc Line, Cup-Type Line and Angle Filters

During installation, check the flow direction. Angle filters should be installed so that the filter element can be replaced from below.

### High-Pressure Threaded Connection - Plug

- 01 Insert the plug into the body.
- 02 Thread the gland into the body connection and tighten to the torque specified in the table below.

Pressure Rating psi (bar)	Tube connection dimensions In.	O.D. Tube (mm)	Gland Wrench size (Ws) In. (mm)	Torque value Nm
15,000 (1,034)	1-1/2	38.1	1-7/8 (48)	275
20,000 (1,379)	1/4	6.35	1/2 (13)	28
	3/8	9.53	5/8 (16)	41
	9/16	14.29	15/16 (24)	75
	3/4	19.05	1-3/16 (30)	122
	1	25.40	1-3/8 (35)	204
30,000(2,068) / 60,000 (4,137)	1/4	6.35	5/8 (16)	34
	3/8	9.53	13/16 (21)	68
	9/16	14.29	1-3/16 (30)	150
100,000 (6,896)	1/4	6.35	5/8 (16)	34
	3/8	9.53	13/16 (21)	68
	9/16	14.29	1-3/16 (30)	150
150,000 (10,344)	5/16	7.94	3/4 (19)	95



Technical Information

Basic Information

High-Pressure Fluid Systems: Operating Conditions

Handling of High-Pressure Tubing

Threaded Connections in Fluid Systems

Valve Design Types

Installation

Disassembly

Maintenance

Repair

Annexes

Conversation Tables

# Technical Information

## Disassembly

Disassembly of HiFluid ultra-high pressure valves, fittings and tubing should be carried out in the reverse order of installation.

**⚠ Never disassemble ultra-high-pressure valves, fittings and tubing while under pressure!**

## Maintenance

HiFluid ultra-high-pressure valves, fittings and tubing generally require no maintenance except for filters. When filter elements become contaminated or clogged and performance declines, they should be replaced promptly to ensure safe and stable system operation.

## Repair

Repairs must only be carried out by trained professionals.



- Basic Information
- High-Pressure Fluid Systems: Operating Conditions
- Handling of High-Pressure Tubing
- Threaded Connections in Fluid Systems
- Valve Design Types
- Installation
- Disassembly**
- Maintenance**
- Repair**
- Annexes
- Conversation Tables

# Annex 1—Torque Values

Tubing Size O.D. x I.D. in. (mm)	Tubing Pressure psi (bar) @R.T.	Connection Type	Tube Gland Hex Size in. (mm)	Required Torque ft-lbs.(Nm)
1/4 x .109 (6.35 x 2.77)	20,000 (1,379)	M4	1/2 (13)	20 (28)
3/8 x .203 (9.53 x 5.17)	20,000 (1,379)	M6	5/8 (16)	30 (41)
9/16 x .312 (14.29 x 7.93)	20,000 (1,379)	M9	15/16 (24)	55 (75)
9/16 x .359 (14.29 x 9.13)	15,000 (1,034)	M9	15/16 (24)	55 (75)
3/4 x .438 (19.05 x 11.12)	20,000 (1,379)	M12	1-3/16 (30)	90 (122)
3/4 x .516 (19.05 x 13.11)	15,000 (1,034)	M12	1-3/16 (30)	90 (122)
1 x .562 (25.4 x 14.27)	20,000 (1,379)	M16	1-3/8 (35)	150 (204)
1 x .688 (25.4 x 17.47)	15,000 (1,034)	M16	1-3/8 (35)	150 (204)
1-1/2 x .937 (38.1 x 23.8)	15,000 (1,034)	M24	1-7/8 (48)	200 (275)
1/4 x .083 (6.35 x 2.11)	60,000 (4,137)	H4	5/8 (16)	25 (34)
3/8 x .125 (9.53 x 3.17)	60,000 (4,137)	H6	13/16 (21)	50 (68)
9/16 x .188 (14.29 x 4.77)	60,000 (4,137)	H9	1-3/16 (30)	110 (150)
1 x .438 (25.4 x 11.13)	43,000 (2,965)	M16H	1-3/8 (35)	150 (204)
1/4 x .083 (6.35 x 1.59)	100,000 (6,896)	U4	5/8 (16)	25 (34)
3/8 x .125 (9.53 x 3.17)	100,000 (6,896)	U6	13/16 (21)	50 (68)
9/16 x .188 (14.29 x 4.77)	100,000 (6,896)	U9	1-3/16 (30)	110 (150)
5/16 x .062 (7.94 x 1.58)	150,000 (10,344)	U5	3/4 (19)	70 (95)

 Technical Information

- Basic Information
- High-Pressure Fluid Systems: Operating Conditions
- Handling of High-Pressure Tubing
- Threaded Connections in Fluid Systems
- Valve Design Types
- Installation
- Disassembly
- Maintenance
- Repair
- Annexes**
  - Torque Values**
  - Anti-Vibration Torque Values
  - Needle Valve Torque Values
  - Recommended Bend Radius for 316SS Tubing
  - Tube Connection Details
- Conversation Tables

# Annex 2—Anti-Vibration Torque Values

Tubing Size O.D. x I.D. in. (mm)	Tubing Pressure psi (bar) @R.T.	Connection Type	Tube Gland Hex Size in. (mm)	Required Torque ft-lbs.(Nm)
1/4 x .109 (6.35 x 2.77)	20,000 (1,379)	M4	5/8 (16)	15 (21)
3/8 x .203 (9.53 x 5.17)	20,000 (1,379)	M6	13/16 (21)	20 (28)
9/16 x .312 (14.29 x 7.93)	20,000 (1,379)	M9	15/16 (24)	35 (48)
9/16 x .359 (14.29 x 9.13)	15,000 (1,034)	M9	15/16 (24)	35 (48)
3/4 x .438 (19.05 x 11.12)	20,000 (1,379)	M12	5/4 (32)	60 (82)
3/4 x .516 (19.05 x 13.1)	15,000 (1,034)	M12	5/4 (32)	60 (82)
1 x .562 (25.4 x 14.27)	20,000 (1,379)	M16	1-1/4 (38)	100 (136)
1 x .688 (25.4 x 17.47)	15,000 (1,034)	M16	1-1/4 (38)	100 (136)
1-1/2 x .937 (38.1 x 23.8)	15,000 (1,034)	M24	2- 1/4 (57)	160 (220)
1/4 x .083 (6.35 x 2.11)	60,000 (4,137)	H4	5/8 (16)	20 (28)
3/8 x .125 (9.53 x 3.17)	60,000 (4,137)	H6	13/16 (21)	30 (41)
9/16 x .188 (14.29 x 4.77)	60,000 (4,137)	H9	1-3/16 (30)	60 (82)
1 x .438 (25.4 x 11.13)	43,000 (2,965)	M16H	1-1/2 (38)	100 (136)



- Basic Information
- High-Pressure Fluid Systems: Operating Conditions
- Handling of High-Pressure Tubing
- Threaded Connections in Fluid Systems
- Valve Design Types
- Installation
- Disassembly
- Maintenance
- Repair
- Annexes
  - Torque Values
  - Anti-Vibration Torque Values
  - Needle Valve Torque Values
  - Recommended Bend Radius for 316SS Tubing
  - Tube Connection Details
- Conversation Tables

# Annex 3—Needle Valve Torque Values

Valve Series @R.T.	O.D. Size in. (mm)	Packing Gland Hex in. (mm) Size	Packing Gland Torque ft.-lbs Nm	Running Torque in.-lbs. Nm	Seating Torque in.-lbs. Nm
Low-Pressure Needle Valve 15V  Medium-Pressure Needle Valve 20V	1/4 (6.35)	5/8 (16)	41	5	7
	3/8 (9.53)	5/8 (16)	41	5	7
	9/16 (14.29)	13/16 (21)	82	7	11
	3/4 (19.05)	15/16 (24)	3/4 turn	34	41
	1 (25.4)	1-3/8 (35)	3/4 turn	41	68
	1-1/2 (38.1)	1-5/8 (42)	50	90	100
High-Pressure Needle Valve 30V	1/4 (6.35)	13/16 (21)	61	6	7
	3/8 (9.53)				
	9/16 (14.29)				
High-Pressure Needle Valve 43V	1 (25.4)	1-3/8 (35)	3/4 turn	41	68
High-Pressure Needle Valve 60V	1/4 (6.35)	9/16 (14.29)	48	8	9
	3/8 (9.53)				
	9/16 (14.29)				
Ultra-High Pressure Needle Valve 100V	1/4 (6.35)	13/16 (21)	55	8	9
	3/8 (9.53)				
	9/16 (14.29)				
	5/16 (7.94)	15/16 (24)	82	12	14

 Technical Information

- Basic Information
- High-Pressure Fluid Systems: Operating Conditions
- Handling of High-Pressure Tubing
- Threaded Connections in Fluid Systems
- Valve Design Types
- Installation
- Disassembly
- Maintenance
- Repair
- Annexes
  - Torque Values
  - Anti-Vibration Torque Values
  - Needle Valve Torque Values**
  - Recommended Bend Radius for 316SS Tubing
  - Tube Connection Details
- Conversation Tables

# Annex 4—Recommended Bend Radius for 316SS Tubing

Tubing Size O.D. x I.D in. (mm)	Tubing Pressure psi (bar) @R.T	Recommended Minimum Bend Radius in. (mm)
1/4 x .109 (6.35 x 2.77)	20,000 (1,379)	1.25 (31.8)
3/8 x .203 (9.53 x 5.17)	20,000 (1,379)	1.75 (44.5)
9/16 x .312 (14.29 x 7.93)	20,000 (1,379)	2.63 (66.8)
9/16 x .359 (14.29 x 9.13)	15,000 (1,034)	2.63 (66.8)
3/4 x .438 (19.05 x 11.12)	20,000 (1,379)	3.50 (88.9)
3/4 x .516 (19.05 x 13.1)	15,000 (1,034)	3.50 (88.9)
1 x .562 (25.4 x 14.27)	20,000 (1,379)	4.63 (117.6)
1 x .688 (25.4 x 17.47)	15,000 (1,034)	4.63 (117.6)
1-1/2x .937 (38.1 x 23.8)	15,000 (1,034)	6.5 (165.1)
1/4 x .083 (6.35 x 2.11)	60,000 (4,137)	1.25 (31.8)
3/8 x .125 (9.53 x 3.17)	60,000 (4,137)	1.75 (44.5)
9/16 x .188 (14.29 x 4.77)	60,000 (4,137)	2.63 (66.8)
1 x .438 (25.4 x 11.13)	43,000 (2,965)	4.63 (117.6)
5/16 x .062 (7.94 x 1.58)	150,000 (10,344)	6.00 (152.4)

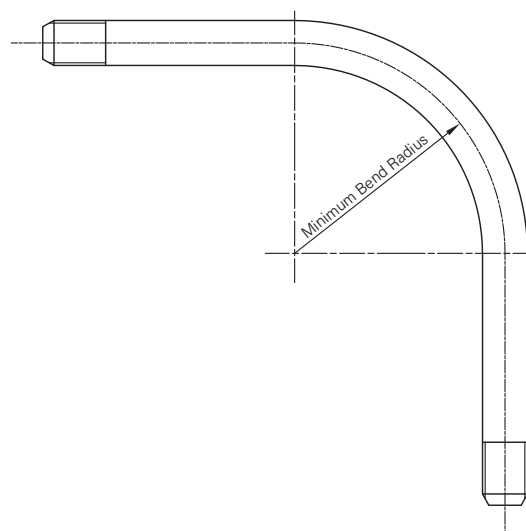

**Technical Information**

- Basic Information
- High-Pressure Fluid Systems: Operating Conditions
- Handling of High-Pressure Tubing
- Threaded Connections in Fluid Systems
- Valve Design Types
- Installation
- Disassembly
- Maintenance
- Repair
- Annexes**
  - Torque Values
  - Anti-Vibration Torque Values
  - Needle Valve Torque Values
  - Recommended Bend Radius for 316SS Tubing**
  - Tube Connection Details
- Conversation Tables

# Annex 5—Tube Connection Details

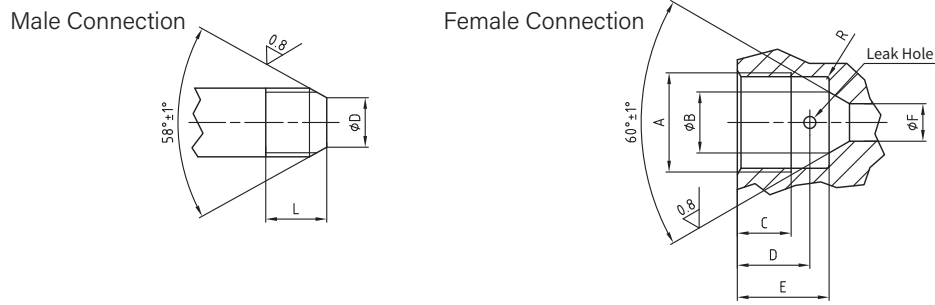

Tubing Size O.D. x I.D in. (mm)	Tubing Pressure psi (bar) @R.T.	Dimension in. (mm)			Male Conn. Type	Female Conn. Type	Dimension in.(mm)						Tubing Engagement Allowance
		D	L	Left Hand Thread			A*	B(±0.1)	C	D	E	F**	
<b>Medium-Pressure</b>													
1/4 x .109 (6.35 x 2.77)	20,000 (1,379)	0.141 (3.6)	0.344 (8.7)	1/4-28	M4	M4	7/16-20	0.19 (4.7)	0.28 (7)	0.37 (9.5)	0.51 (13)	0.109 (2.7)	0.55 (14)
3/8 x .203 (9.53 x 5.17)	20,000 (1,379)	0.250 (6.4)	0.438 (11.1)	3/8-24	M6	M6	9/16-18	0.31 (7.7)	0.38 (9.6)	0.50 (12.7)	0.62 (15.7)	0.203 (5.1)	0.69 (17.5)
9/16 x .312 (14.29 x 7.93)	20,000 (1,379)	0.406 (10.3)	0.500 (12.7)	9/16-18	M9	M9	13/16-16UN	0.50 (12.7)	0.44 (11.2)	0.59 (15.1)	0.75 (19.1)	0.312 (7.8)	0.84 (21.3)
9/16 x .359 (14.29 x 9.13)	15,000 (1,034)	0.438 (11.1)	0.500 (12.7)	9/16-18	M9	M9	13/16-16UN	0.50 (12.7)	0.44 (11.2)	0.59 (15.1)	0.75 (19.1)	0.359 (9.1)	0.83 (21.1)
3/4 x .438 (19.05 x 11.12)	20,000 (1,379)	0.562 (14.3)	0.625 (15.9)	3/4-16	M12	M12	3/4-14 NPSM	0.62 (15.7)	0.50 (12.7)	0.72 (18.3)	0.94 (23.9)	0.438 (11.1)	1.00 (25.4)
3/4 x .516 (19.05 x 13.1)	15,000 (1,034)	0.578 (14.7)	0.625 (15.9)	3/4-16	M12	M12	3/4-14 NPSM	0.62 (15.7)	0.50 (12.7)	0.72 (18.3)	0.94 (23.9)	0.516 (13.1)	0.99 (25.1)
1 x .562 (25.4 x 14.17)	20,000 (1,379)	0.719 (18.1)	0.781 (19.8)	1-14 UNS	M12	M12	1-1/8-12	0.88 (22.4)	0.81 (20.6)	1.06 (27)	1.31 (33.3)	0.562 (14.3)	1.44 (36.6)
1 x .688 (25.4 x 17.47)	15,000 (1,034)	0.719 (18.1)	0.781 (19.8)	1-14 UNS	M16	M16	1-3/8-12	0.88 (22.4)	0.81 (20.6)	1.06 (27)	1.31 (33.3)	0.688 (17.5)	1.38 (35.1)
<b>High-Pressure</b>													
1/4 x .083 (6.35 x 2.11)	60,000 (4,137)	0.125 (3.2)	0.562 (14.3)	1/4-28	H4	H4	9/16-18	0.17 (4.2)	0.39 (10)	0.39 (10)	0.45 (11.5)	0.094 (2.3)	0.50 (12.7)
3/8 x .125 (9.53 x 3.17)	60,000 (4,137)	0.219 (5.6)	0.750 (19.1)	3/8-24	H6	H6	3/4-16	0.26 (6.5)	0.53 (13.5)	0.53 (13.5)	0.63 (16)	0.125 (3.2)	0.69 (17.5)
9/16 x .188 (14.29 x 4.77)	60,000 (4,137)	0.281 (7.1)	0.938 (23.8)	9/16-18	H9	H9	1-1/8-12	0.38 (9.7)	0.62 (15.7)	0.62 (15.7)	0.75 (19.1)	0.188 (4.8)	0.84 (21.3)
1 x .438 (25.4 x 11.13)	43,000 (2,965)	0.563 (14.3)	1.083 (27.5)	1-14	M16H	M16H	1-3/8-12	0.88 (22.4)	0.81 (20.6)	1.06 (27)	1.31 (33.3)	0.438 (11.1)	1.59 (40.3)
<b>Ultra-High Pressure</b>													
1/4 x .063 (6.35 x 1.59)	100,000 (6,896)	0.125 (3.2)	0.562 (14.3)	1/4-28	U4	U4	9/16-18	0.17 (4.2)	0.39 (10)	0.39 (10)	0.45 (11.5)	0.094 (2.3)	0.50 (12.7)
3/8 x .125 (9.53 x 3.17)	100,000 (6,896)	0.219 (5.6)	0.750 (19.1)	3/8-24	U6	U6	3/4-16	0.26 (6.5)	0.53 (13.5)	0.53 (13.5)	0.63 (16)	0.118 (3)	0.69 (17.5)
9/16 x .188 (14.29 x 4.77)	100,000 (6,896)	0.281 (7.1)	0.938 (23.8)	9/16-18	U9	U9	1-1/8-12	0.38 (9.7)	0.62 (15.7)	0.62 (15.7)	0.75 (19.1)	0.188 (4.8)	0.84 (21.3)
5/16 x 0.62 (7.95 x 1.58)	150,000 (10,344)	0.125 (3.2)	0.687 (17.4)	5/16-24	U5	U5	5/8-18	0.25 (6.2)	0.63 (16)	0.93 (23.5)	1.06 (27)	0.09 (2.3)	1.25 (31.75)

\* Standard fine thread, Class 2.

\*\* Bore diameter may vary depending on valve or fitting type.

-  Technical Information
- Basic Information
- High-Pressure Fluid Systems: Operating Conditions
- Handling of High-Pressure Tubing
- Threaded Connections in Fluid Systems
- Valve Design Types
- Installation
- Disassembly
- Maintenance
- Repair
- Annexes
  - Torque Values
  - Anti-Vibration Torque Values
  - Needle Valve Torque Values
  - Recommended Bend Radius for 316SS Tubing
  - Tube Connection Details**
- Conversation Tables

# Conversation Tables

## Temperature Equivalents

Celsius[°C]	Kelvin[K]	Fahrenheit[°F]	Rankine[°R]
0	273	32	492
-273	0	-460	0
-18	255	0	460

## Linear Equivalents

meter[m]	centimeter[cm]	millimeter[mm]	foot[ft]	inch[in]
1	100	1000	3.28083	39.37
0.01	1	10	0.03281	0.3937
0.001	0.1	1	0.003281	0.03937
0.3048	30.48	304.8	1	12
0.0254	2.54	25.4	0.0833	1

## Pressure Equivalents

Pascal[Pa]	MPascal[MPa]	Bar[bar]	[psi]	kg/cm <sup>2</sup>
1	1x10 <sup>-6</sup>	1x10 <sup>-5</sup>	1.4504x10 <sup>-4</sup>	1.0197x10 <sup>-5</sup>
1x10 <sup>6</sup>	1	10	145.04	10.1971
100000	0.1	1	14.504	1.01971
6894.757	6.8948x10 <sup>-3</sup>	0.06895	1	0.07031
98066.5	0.098067	0.98067	14.223	1

## Volume Equivalents

meter <sup>3</sup> [m <sup>3</sup> ]	liter[l]	foot <sup>3</sup> [ft <sup>3</sup> ]	inch <sup>3</sup> [in <sup>3</sup> ]	gallon*
1	1000	35.31	61023	264.2
1x10 <sup>-3</sup>	1	0.3531	61.023	0.2642
28.317x10 <sup>-3</sup>	28.317	1	1728	7.4822
1.638x10 <sup>-5</sup>	0.1639	5.787x10 <sup>-4</sup>	1	43.29x10 <sup>-4</sup>
3.785x10 <sup>-3</sup>	3.785	0.1337	231	1

\* U.S. Gallons.

-  Technical Information
- Basic Information
- High-Pressure Fluid Systems: Operating Conditions
- Handling of High-Pressure Tubing
- Threaded Connections in Fluid Systems
- Valve Design Types
- Installation
- Disassembly
- Maintenance
- Repair
- Annexes
- Conversation Tables**

# Conversation Tables

## Density Equivalents

kg/m <sup>3</sup>	g/cm <sup>3</sup>	pound/ft <sup>3</sup>	pound/in <sup>3</sup>	pound/gallon*
1	0.001	0.062427	3.613×10 <sup>-5</sup>	0.008345
1000	1	62.427	0.03613	8.3454
16.018	0.016018	1	5.787×10 <sup>-4</sup>	0.13368
27679.9	27.6799	1728	1	231
119.826	0.11983	7.4805	4.33×10 <sup>-3</sup>	1

## Fluid Flow Equivalents

m <sup>3</sup> /h	m <sup>3</sup> /min	l/h	l/min	gallon*/h	gallon*/min
1	0.01667	1000	16.667	264.172	4.4029
60	1	60000	1000	15850.3	264.17
0.001	1.667×10 <sup>-5</sup>	1	0.01667	0.26417	4.4029×10 <sup>-3</sup>
0.06	0.001	60	1	15.85	0.26417
3.7854×10 <sup>-3</sup>	6.309×10 <sup>-5</sup>	3.7854	0.06309	1	0.01667
0.2271	3.7854×10 <sup>-3</sup>	227.1247	3.7854	60	1

## Area Equivalents

m <sup>2</sup>	cm <sup>2</sup>	mm <sup>2</sup>	ft <sup>2</sup>	in <sup>2</sup>
1	1×10 <sup>4</sup>	1×10 <sup>6</sup>	10.7639	1550
1×10 <sup>-4</sup>	1	100	1.0764×10 <sup>-3</sup>	0.155
1×10 <sup>-6</sup>	0.01	1	1.0764×10 <sup>-5</sup>	1.55×10 <sup>-3</sup>
0.0929	929.03	92903.04	1	144
6.4516×10 <sup>-4</sup>	6.4516	645.1625	6.944×10 <sup>-3</sup>	1

## Velocity Equivalents

km/h	m/min	m/s	fpm	fps
1	16.667	0.2778	54.6807	0.9113
0.06	1	0.01667	3.2808	0.05468
3.6	60	1	196.85	3.2808
1.829×10 <sup>-2</sup>	0.3048	0.00508	1	0.01667
1.09728	18.288	0.3048	60	1

-  Technical Information
- Basic Information
- High-Pressure Fluid Systems: Operating Conditions
- Handling of High-Pressure Tubing
- Threaded Connections in Fluid Systems
- Valve Design Types
- Installation
- Disassembly
- Maintenance
- Repair
- Annexes
- Conversation Tables**

